

DIN W48×H24mm Small Digital Multi Panel Meter

■ Features

- Various input options (by model)
 - Input options: DC voltage, DC current, AC voltage, AC current
- Isolated input and power modules allow powering of multiple units using a single power supply
- Display range: -1999 to 9999
- High/low-limit display scale function
- AC frequency measurement (range: 0.1 to 9999Hz)
- Preset output mode: OUT1, GO, OUT2 (NPN/PNP open collector output)
- Power factor display function: displays analog outputs (1-5V, 4-20mA) from power factor converters as -0.50 to 1.00 to 0.50
- Various functions: peak display value monitoring, display cycle delay, zero-point adjustment, peak display value correction
- Power supply: 5-24VDC (isolated type)



⚠ Please read "Safety Considerations" in the instruction manual before using.



■ Ordering Information

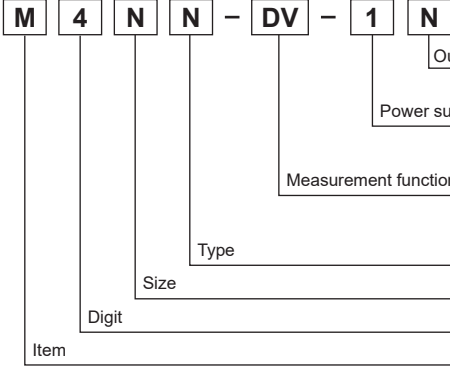

Output	N	Indicator
	1	NPN open collector output
	2	PNP open collector output
Power supply	1	5-24VDC
Measurement function (input)	DV	DC Voltage (minus input)
	DA	DC Current (minus input)
	AV	AC Voltage
	AA	AC Current
Type	N	New Type
Size	N	DIN W48×H24mm
Digit	4	9999 (4-digit)
Item	M	Multi Meter

■ Unit Description

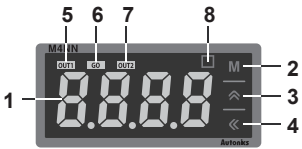

1. Measurement value display part
2. **M** Key: MODE key
3. **⬆** Key: Up key
4. **⬇** Key: Shift key
5. **OUT1 (red)**: OUT1 output indicator of preset
6. **GO (green)**: GO output indicator of preset
7. **OUT2 (red)**: OUT2 output indicator of preset
8. Unit sticker

■ Dimensions

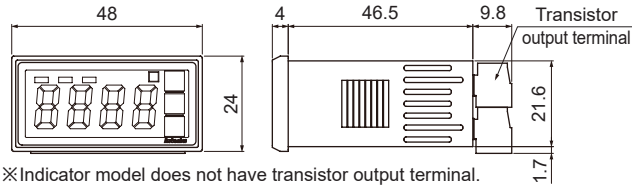

※Indicator model does not have transistor output terminal.

●Panel cut-out

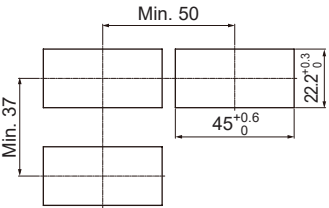

●Bracket

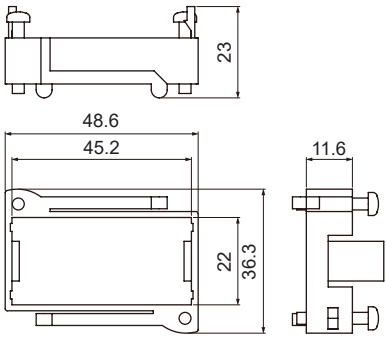

SENSORS
CONTROLLERS
MOTION DEVICES
SOFTWARE
(J) Temperature Controllers
(K) SSRs
(L) Power Controllers
(M) Counters
(N) Timers
(O) Digital Panel Meters
(P) Indicators
(Q) Converters
(R) Digital Display Units
(S) Sensor Controllers
(T) Switching Mode Power Supplies
(U) Recorders
(V) HMIs
(W) Panel PC
(X) Field Network Devices

M4NN Series

Specifications

Model	M4NN-DV-1□	M4NN-DA-1□	M4NN-AV-1□	M4NN-AA-1□
Measurement input	DC voltage	DC current	AC voltage, frequency	AC current, frequency
Max. allowable input	-110 to 110% of the rated measurement input range (when not using minus input: -10 to 110%)		Approx. 110% of the rated measurement input range	
Power supply	5-24 VDC≒			
Allowable voltage range	90 to 110% of the rated voltage (5V is fixed for lower limit)			
Power consumption	Max. 3W			
Display method	7-segment LED display (red) (character height: 11mm)			
Display accuracy	• 23°C±5°C-DC Input: ±0.1% F.S. ±2-digit / AC Input ±0.3% F.S. ±3-digit ※For 5A terminal of current Input, ±0.3% F.S. ±3-digit • -10 to 50°C-DC/AC Input: ±0.5% F.S. ±3-digit / Frequency: ±0.5% F.S. ±3-digit ※For 5A terminal of current Input, ±1% F.S. ±3-digit			
Display cycle	0.1 to 5.0 sec (selectable by 0.1 sec)			
A/D conversion method	Practical oversampling using successive approximation ADC			
Sampling cycle	50ms (resolution 1/12,000)		16.6ms (resolution 1/12,000)	
Max. display range	-1999 to 9999 (4-digit)			
Preset output* ¹	NPN/PNP open collector output: • Load voltage: max. 30VDC≒ • Load current: max. 100mA • Residual voltage: max. 1VDC≒ (NPN), max. 2VDC (PNP)			
AC measurement* ²	—		Average value (AVG) measurement	
Frequency measurement* ²	—		Measurement range: 0.100 to 9999Hz (variable by decimal point position)	
Insulation resistance	Over 100MΩ (at 500VDC megger)			
Dielectric strength	2000VAC 50/60Hz for 1 min (between all terminals and case)			
Noise immunity	±2kV the square wave noise (pulse width: 1μs) by the noise simulator			
Vibration	Mechanical	0.75mm amplitude at frequency of 10 to 55Hz (for 1 min) in each X, Y, Z direction for 2 hours		
	Malfunction	0.5mm amplitude at frequency of 10 to 55Hz (for 1 min) in each X, Y, Z direction for 10 min		
Shock	Mechanical	100m/s ² (approx. 10G) in each X, Y, Z direction for 3 times		
	Malfunction	300m/s ² (approx. 30G) in each X, Y, Z direction for 3 times		
Environment	Ambient temperature	-10 to 50°C, storage: -20 to 60°C		
	Ambient humidity	35 to 85%RH, storage: 35 to 85%RH		
Connection	Plug/Socket terminal block (accessory)			
Insulation type	Double insulation or reinforced insulation (mark: □, dielectric strength between the measurement input part and the power part: 1kV)			
Approval	CE			
Weight* ³	Approx. 83.6g (approx. 46.8g)	Approx. 83.7g (approx. 46.7g)	Approx. 83.8g (approx. 46.9g)	Approx. 83.8g (approx. 46.9g)

※1: Indicator model (M4NN-□□-1N) does not have output function.

※2: AC, frequency measurement functions are only for AC measurement type.

※3: The weight includes packaging. The weight in parenthesis is for unit only.

※Environment resistance is rated at no freezing or condensation.

Connections

M4NN-DV-1□

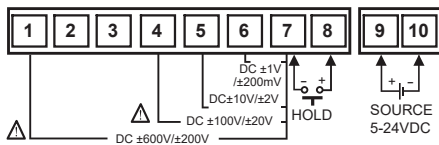

M4NN-AV-1□

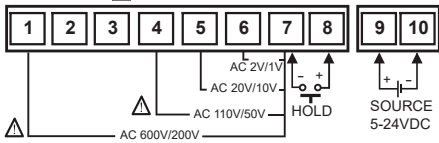

NPN Open Collector

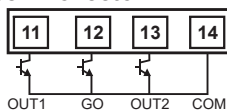

PNP Open Collector

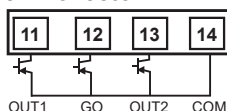

M4NN-DA-1□

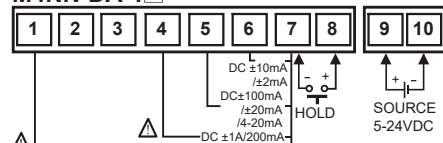

M4NN-AA-1□

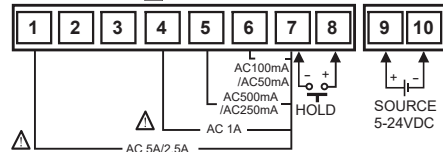

※Input and output are insulated from the power.

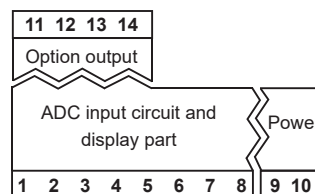

Small Multi Panel Meter

Parameter Settings

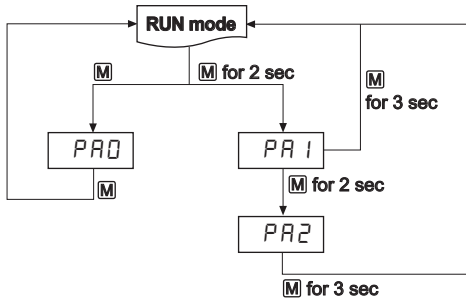

Parameter 1 Group

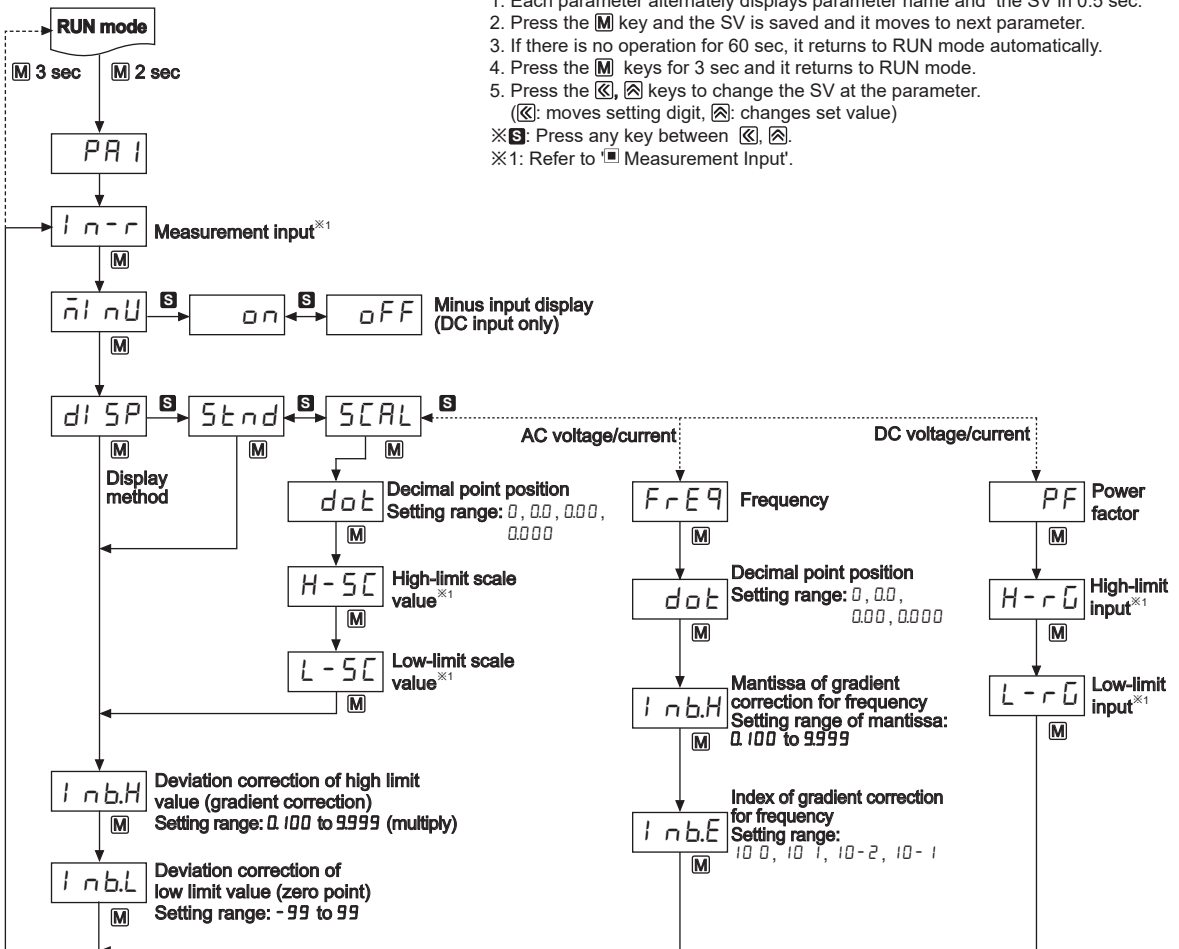

Parameter setting

1. Each parameter alternately displays parameter name and the SV in 0.5 sec.
 2. Press the **M** key and the SV is saved and it moves to next parameter.
 3. If there is no operation for 60 sec, it returns to RUN mode automatically.
 4. Press the **M** keys for 3 sec and it returns to RUN mode.
 5. Press the **⏪**, **⏩** keys to change the SV at the parameter.
 (⏪: moves setting digit, ⏩: changes set value)
- ※**S**: Press any key between **⏪**, **⏩**.
 ※1: Refer to **Measurement Input**.

Factory default

Parameter	M4NN-DV	M4NN-DA	M4NN-AV	M4NN-AA	Parameter	M4NN-DV	M4NN-DA	M4NN-AV	M4NN-AA
in-r	600u	5A	600u	5A	inb.H	1000	1000	1000	1000
nlnu	on	on	—	—	inb.L	00	00	00	00
diSP	Stnd	Stnd	Stnd	Stnd	H-rG	600	500	—	—
dot	0	0	0	0	L-rG	-600	-500	—	—
H-SC	600	500	600	5000	inb.E	—	—	10 0	10 0
L-SC	-600	-500	0	0					

SENSORS
CONTROLLERS
MOTION DEVICES
SOFTWARE

(J) Temperature Controllers
(K) SSRs
(L) Power Controllers
(M) Counters
(N) Timers
(O) Digital Panel Meters
(P) Indicators
(Q) Converters
(R) Digital Display Units
(S) Sensor Controllers
(T) Switching Mode Power Supplies
(U) Recorders
(V) HMIs
(W) Panel PC
(X) Field Network Devices

M4NN Series

Parameter 2 Group

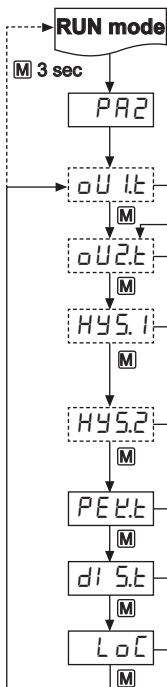

Parameter (0 to 2) group setting method

1. Each parameter alternately displays parameter name and the SV in 0.5 sec.
2. Press the **M** key and the SV is saved and it moves to next parameter.
3. If there is no operation for 60 sec, it returns to RUN mode automatically.
4. Press the **M** keys for 3 sec and it returns to RUN mode.
5. Press the **◀**, **▶** keys to change the SV at the parameter.
 (◀: moves setting digit, ▶: changes set value)
 ※ **S**: Press any key between ◀, ▶.

oU1t **S** **oFF** Preset output operation mode of OUT1 (displayed only for OUT 1 output model)
 Setting range: oFF, H1, Lo, HL, HL-G

oU2t **S** **oFF** Preset output operation mode of OUT2 (displayed only for OUT 2 output model)

HYS.1 **S** **001** Preset hysteresis of OUT1
 Setting range: within 10% of max. display range (unit: digit)
 ※When oU1t parameter is oFF, it is not displayed.

HYS.2 **S** **001** Preset hysteresis of OUT2
 Setting range: within 10% of max. display range (unit: digit)
 ※When oU2t parameter is oFF, it is not displayed.

PEELt **S** **005** When initially supplying power, delays monitoring of high-limit/low-limit value of display value for the set time.
 Setting range: 00 to 30 sec
 ※If it is set to 00 sec [005], parameters of high-peak monitoring value [HPEELt]/low-limit monitoring value [LPEELt] in the parameter 0 group will be not displayed.

diSt **S** **0.25** Display cycle
 Setting range: 0.1 to 5.0 sec

LoC **S** **oFF** Lock among 4 types.
 Setting range: oFF, LoC1, LoC2, LoC3

oFF	Unlock
LoC1	Lock Parameter 1 group
LoC2	Lock Parameter 1, 2 groups
LoC3	Lock Parameter 0, 1, 2 groups

Factory default

Parameter	M4NN-DV	M4NN-DA	M4NN-AV	M4NN-AA	Parameter	M4NN-DV	M4NN-DA	M4NN-AV	M4NN-AA
oU1t ^{※1}	oFF	oFF	oFF	oFF	PEELt	005	005	005	005
oU2t ^{※1}	oFF	oFF	oFF	oFF	diSt	0.25	0.25	0.25	0.25
HYS.1 ^{※1}	—	—	—	—	LoC	oFF	oFF	oFF	oFF
HYS.2 ^{※1}	—	—	—	—					

※It is not displayed for the indicator model.

Parameter 0 Group

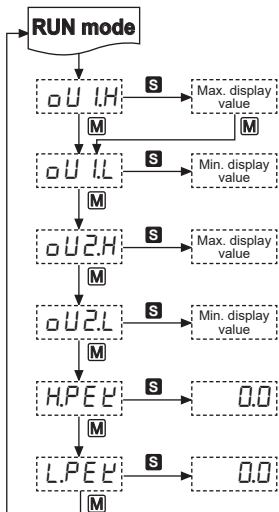

oU1H **S** Max. display value
 High-limit preset of oU1t
 ※Not displayed when oU1t parameter is oFF at the parameter 2 group.

oU1L **S** Min. display value
 Low-limit preset of oU1t
 ※Not displayed when oU1t parameter is oFF at the parameter 2 group.

oU2H **S** Max. display value
 High-limit preset of oU2t
 ※Not displayed when oU2t parameter is oFF at the parameter 2 group.

oU2L **S** Min. display value
 Low-limit preset of oU2t
 ※Not displayed when oU2t parameter is oFF at the parameter 2 group.

HPEELt **S** 00 It displays max. monitoring value (high peak value) in RUN mode.
 Press any key between ◀, ▶ and it is initialized (reset).
 ※HPEELt parameter is not displayed when PEELt parameter is set as 00 sec[005] at the parameter 2 group.

LPEELt **S** 00 It displays min. monitoring value (low-limit value) in RUN mode.
 Press any key between ◀, ▶ and it is initialized (reset).
 ※LPEELt parameter is not displayed when PEELt parameter is set as 00 sec[005] at the parameter 2 group.

Small Multi Panel Meter

○ Factory default

Parameter	M4NN-DV	M4NN-DA	M4NN-AV	M4NN-AA	Parameter	M4NN-DV	M4NN-DA	M4NN-AV	M4NN-AA
$\square U_{IH}^{*1}$	600	5.00	600.0	5.000	$\square U_{2L}^{*1}$	-600	-5.00	000.0	0.000
$\square U_{LL}^{*1}$	-600	-5.00	000.0	0.000	HPE \square^{*1}	0	0.00	0.0	0.000
$\square U_{2H}^{*1}$	600	5.00	600.0	5.000	LPE \square^{*1}	0	0.00	0.0	0.000

※It is not displayed for the indicator model.

■ Measurement Input

Type	Measurement input range	Input impedance	Display range [5 t n d]	Note
DC voltage	-600-600V [500.0]	4.694MΩ	-600 to 600	※For DC input, not to display minus input, set minus input display [n i n U] of parameter 1 group as $\square FF$. E.g.) When the display range is -600 to 600V, set n i n U of parameter 1 group as $\square FF$ and this display range is 0 to 600V.
	-200-200V [200.0]	4.694MΩ	-199.9 to 200.0	
	-100-100V [100.0]	794kΩ	-100.0 to 100.0	
	-20-20V [20.0]	79kΩ	-19.99 to 20.00	
	-10-10V [10.0]	79kΩ	-10.00 to 10.00	
	-2-2V [2.0]	79kΩ	-1.999 to 2.000	
	-1-1V [1.0]	7.5kΩ	-1.000 to 1.000	
DC current	-200-200mV [0.20]	7.5kΩ	-199.9 to 200.0	(display range is variable according to decimal point position)
	-5-5A [5A]	0.01kΩ	-5.00 to 5.00	
	-2-2A [2A]	0.01Ω	-1.999 to 2.000	
	-1-1A [1A]	0.1Ω	-1.000 to 1.000	
	-200-200mA [0.2A]	0.1Ω	-199.9 to 200.0	
	-100-100mA [0.1A]	1.1Ω	-100.0 to 100.0	
	-20-20mA [20.0mA]	1.1Ω	-19.99 to 20.00	
	4-20mA [4.20]	1.1Ω	4.00 to 20.00	
	-10-10mA [10.0mA]	11.1Ω	-10.00 to 10.00	
-2-2mA [2.0mA]	11.1Ω	-1.999 to 2.000	※Connect to the input terminals whose 30% to 100% of the input range includes the max. value of the input range to measure. When the max. input value is under the 30% of the input terminal range, display accuracy is degraded. When the max. input value is over the 100%, it may result in input terminal damage.	
AC voltage	0-600V [600.0]	4.987MΩ	0.0 to 600.0	※For the range setting of AC voltage, when setting as 0 to 110V[110P] and using P.T for 440V/110VAC, 110V is input and 440V is displayed automatically by the set scale value for P.T users' convenience.
	0-250V [250.0]	4.987MΩ	0.0 to 250.0	
	0-110V [110P]	1.087MΩ	0.0 to 440.0	
	0-50V [50.0]	1.087MΩ	0.00 to 50.00	
	0-20V [20.0]	200kΩ	0.00 to 20.00	
	0-10V [10.0]	200kΩ	0.00 to 10.00	
	0-2V [2.0]	20kΩ	0.000 to 2.000	
	0-1V [1.0]	20kΩ	0.000 to 1.000	
AC current	0-5A [5A]	0.01Ω	0.000 to 5.000	※Frequency measurement range (AC voltage/current) : 0.100 to 9999Hz
	0-2.5A [2.5A]	0.01Ω	0.000 to 2.500	
	0-1A [1A]	0.05Ω	0.000 to 1.000	
	0-500mA [0.5A]	0.1Ω	0.0 to 500.0	
	0-250mA [0.25A]	0.1Ω	0.0 to 250.0	
	0-100mA [0.1A]	0.5Ω	0.0 to 100.0	
	0-50mA [50.0mA]	0.5Ω	0.00 to 50.00	

※When "HHHH" or "LLLL" is flashes with a certain measurement input, disconnect power supply and then check the cables.

SENSORS

CONTROLLERS

MOTION DEVICES

SOFTWARE

(J) Temperature Controllers

(K) SSRs

(L) Power Controllers

(M) Counters

(N) Timers

(O) Digital Panel Meters

(P) Indicators

(Q) Converters

(R) Digital Display Units

(S) Sensor Controllers

(T) Switching Mode Power Supplies

(U) Recorders

(V) HMIs

(W) Panel PC

(X) Field Network Devices

■ Functions

○ Minus input display [PA 1 group: $\bar{n}i\ nU$]

- When minus input is unnecessary, or when display 0 not to display minus input due to display minus input due to unstable input value around 0, set as OFF this minus input display function.
- When setting OFF , low-limit value of input range is set 0 and it displays minus input as 0.
- The low-limit value of $L-SL$, OLLL , $L-rG$ parameters is changed based on "0".
Min. display value is "0" and $H-SL$, $H-rG$ parameters display max. value of the input range.
The $i\ nB.H$ / $i\ nB.L$ / OLLL / HYS / OLLL parameters are initialized to factory default.

※ In case of DC current measurement input model, when measurement input range [$n-r$] is set as $4-20$, this parameter is not displayed.

○ AC frequency measurement [PA 1 group: $dI\ 5P$]

It measures input signal frequency when it is an AC input. It uses fixed decimal point by dot parameter setting of parameter 1 group, measured range can be changed by setting and measured range of decimal point position is as below chart. It is available to adjust upper gradient at $i\ nB.H$ and $i\ nB.E$ of parameter 1 group. In order to measure frequency normally, input signal, over 10% F.S. of the measured range, should be supplied. Please select the proper point of measurement terminal.

• Measurement range

Dot position	0.000	0.00	0.0	0
Measurement range	0.100 to 9.999Hz	0.10 to 99.99Hz	0.1 to 999.9Hz	1 to 9999Hz

※ Accuracy of frequency measurement: Below 1kHz, F.S. $\pm 0.1\text{rdg} \pm 2\text{-digit}$, from 1 to 10kHz, F.S. $\pm 0.3\text{rdg} \pm 2\text{-digit}$

- $i\ nB.H$: 0.100 to 9.999
[gradient adjustment of high-limit value]
- $i\ nB.E$: 10^2 , 10^1 , 10^0 , 10^{-1} [index adjustment of $i\ nB.H$]

○ Zero adjustment [low-limit display value deviation correction]

Forces the display value of measured input to 0 (Zero).

- Zero adjustment range: -99 to 99
- Zero adjustment method: Press M and H key in RUN mode for 3 sec.



When zero point adjustment with front key and hold terminal is finished normally, zero point of measurement terminal is displayed and the adjusted value is saved in $i\ nB.L$ automatically.

※ If zero adjustment range is exceeded, the error [OLLE] flashes twice and then move to RUN mode, maintaining previous setting value.

○ Initialization

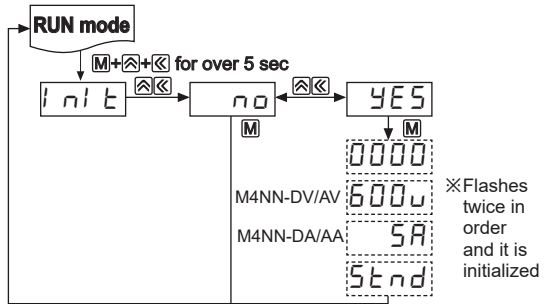

○ Error display

Display	Description
HHHH	Flashes when measured input is exceeded the max. allowable input (+110%)
LLLL	Flashes when measured input is exceeded the min. allowable input (minus input ON : -110%, OFF : -10%)
d-HH	Flashes when display input is exceeded max. display range (9999)
d-LL	Flashes when display input is exceeded min. display range (-1999)
F-HH	Flashes when input frequency is exceeded the max. measured range (10kHz) and display range (9999)
PF-H	Flashes when power factor display value to measured input is over than LAG 0.50
PF-L	Flashes when power factor display value to measured input is less than LEAD -0.50

※ Error is cleared when the input value is within measurement range or display range.

○ Display cycle delay [PA 2 group: $d\ 15.t$]

In some applications the measured input may fluctuate which in turn causes the display to fluctuate. By adjusting the display cycle delay function time at $d\ 15.t$ of parameter 2 group, the operator can adjust the display time within a range of 0.1 sec to 5 sec. For example, if the operator sets the display cycle time to 4.0 sec, the display value is displayed the averaged input value over 4 sec in every 4 sec.

○ Monitoring max./min. display value [PA 0 group: $HPEL/LPEL$, PA 2 group: $PEEL$]

It monitors Max./Min. value of display value based on current display value and then display the data in $HPEL$, $LPEL$ of parameter 0 group. Set delay time (0 to 30 sec) in $PEEL$ mode of parameter 2 group in order to avoid caused by initial overcurrent or over voltage, when monitoring the peak value. Delay time is 0 to 30 sec and it starts to monitor the peak value after set time.

When M , H keys are pressed at $HPEL$, $LPEL$ mode of parameter 0 group, it will be initialized.

※ $HPEL$, $LPEL$ parameters is not displayed when monitoring delay time [$PEEL$] of parameter 2 group is set as 00 sec [$00\ 5$].

Small Multi Panel Meter

◎ Error correction[PA 1 group: i_{nbH} / i_{nbL}]

It corrects display value error of measurement input.

i_{nbL} : -99 to 99 (adjust deviation of low-limit value),

i_{nbH} : 0.100 to 9.999 (correct gradient of high-limit value)

Display value = (measured value $\times i_{nbH}$) + i_{nbL}

E.g.) When the measured range is 0 to 500V, and the display range is 0 to 500.0. If the low display value is 1.2 to 0V input, set -12 as i_{nbL} value to display 0.0 by adjusting offset of the low-limit value. The display value to 500V measured input varies by adjusting the offset of low-limit value. If this display value is 50.10, calculate 500.0/501.0 (desired display value/the display value), and set the 0.998 correction value as the i_{nbH} to display 500.0 by adjusting gradient of high-limit value.

※ The offset correction range of i_{nbL} is within -99 to 99 for D^0 , D^{-1} digit regardless of decimal point position [dot].

※ High limit error correction function is available as “Gradient correction function” and low limit error correction function is available as “Zero adjustment function”.

◎ Gradient correction[PA 1 group: i_{nbH}]

This function is to adjust gradient of standard display value or scale value for the input value within the measured input range. By adjusting gradient, it is available as “High limit error correction function”.

As the below (figure 1), in case of display gradient 1 for the measured input 100V, this function is to adjust display value by adjusting the gradient as 1.5 times or 0.5 times.

• Setting range: 0.100 to 9.999,

Factory default: 1.000 (unit: multiply)

E.g. 1) Gradient adjustment

① When the measured input is 100.0V in order to display 150.0, set gradient correction set value [i_{nbH}] as 1.500.

This value is also applied for minus input. When the measured input is -100.0V, it displays -150.0.

② When the measured input is -100.0V in order to display -50.0, set gradient correction set value [i_{nbH}] as 0.500.

This value is also applied for plus input. When the measured input is 100.0V, it displays 50.0.

	i_{nbH}	Note
①	1.500	※ Shaded part of Figure 1 is not displayed for the below cases. • AC input model • DC input model and minus input [i_{nU}] is set as OFF.
②	0.500	• DC current input model and Input range [i_{n-r}] is set as 4-20.

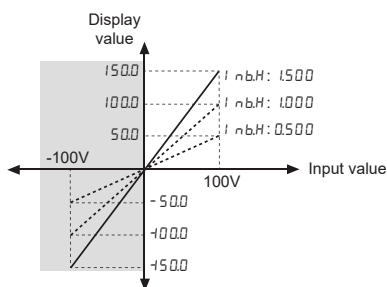

(Figure 1)

E.g. 2) Display scale setting [$L-5C/H-5C$] and gradient adjustment [i_{nbH}] (AC input)

① When the measured input AC 2.000V at the input range AC 0 to 5.000V and it displays 5.000, set decimal point position [dot] as 0.000 before setting the scale value.

② When the measured input is AC 2.000V in order to display 5.000, 12.500 should be displayed when max. input value is 5.000V. However, it cannot set because the max. set value is 9.999.

Set as Gradient correction set value [i_{nbH}] \times High scale value [$H-5C$] = 12,500 as the following table.

③ After this setting is finished, it displays 5.000 when the measured input is 2.000V.

$H-5C$	$L-5C$	i_{nbH}	Note
12.500	0.000	1.000	Unavailable to set because max. set value of $H-5C$ is 9.999
6.250	0.000	2.000	In this case, any setting methods display the same display value.
3.125	0.000	4.000	
2.500	0.000	5.000	

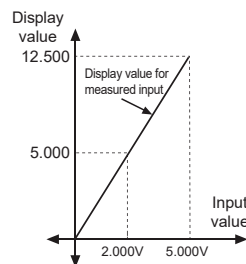

E.g. 3) Display scale setting [$L-5C/H-5C$] and gradient adjustment [i_{nbH}] (DC minus input)

① When the measured input DC -40mA at the input range DC -100.0 to 100.0mA and it displays +50.0, set decimal point position [dot] as 0.000 before setting the scale value.

② When the measured input is DC -40mA in order to display +50.0, -400.0 should be displayed when min. input value is -100.0mA. However, it cannot set because the min. set value is -199.9.

Set as gradient correction set value [i_{nbH}] \times low scale value [$L-5C$] = -400.0 as the following table.

Set high-limit scale value as ($- (L-5C)$) value. If high scale value is set at first, set low scale value as ($- (H-5C)$) value.

③ After this setting is finished, it displays +50.0 when the measured input is DC-40.0mA.

$H-5C$	$L-5C$	i_{nbH}	Note
400.0	-400.0	1.000	Unavailable to set because max. set value of $L-5C$ is -19.99
200.0	-199.9	2.000	In this case, any setting methods display the same display value.
100.0	-100.0	4.000	
80.0	-80.0	5.000	

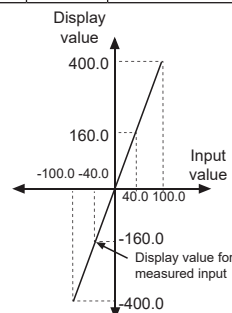

SENSORS
CONTROLLERS
MOTION DEVICES
SOFTWARE

(J) Temperature Controllers

(K) SSRs

(L) Power Controllers

(M) Counters

(N) Timers

(O) Digital Panel Meters

(P) Indicators

(Q) Converters

(R) Digital Display Units

(S) Sensor Controllers

(T) Switching Mode Power Supplies

(U) Recorders

(V) HMIs

(W) Panel PC

(X) Field Network Devices

M4NN Series

◎ Power factor (PF) display

[PA 1 group: H-rG / L-rG]

- This function displays LEAD and LAG by analog output signal from the power factor transducer.
- It is available to accept several outputs of the power factor transducer by high-limit[H-rG]/low-limit[L-rG] analog output value setting in the power factor transducer.
- Power factor value is displayed as $\cos\theta$ value -0.50 (LEAD) to 1.00 to 0.50 (LAG).
- LEAD is when current phase leads voltage phase, LAG is when current phase lags behind voltage phase. LEAD and LAG are invalid power.
- Setting range: From min. to max. selected value from measurement input[r-nr]

E.g.) When setting 200u in r-nr, H-rG and L-rG are available to set from 49.99 to 20000.
When setting 10u, H-rG and L-rG are available to set from 4000 to 10000. (※H-rG > L-rG)

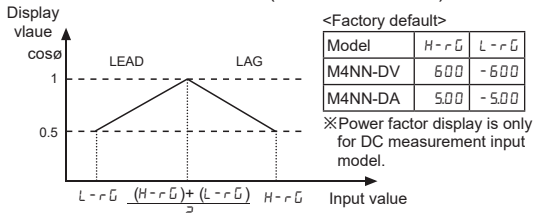

E.g. 1) When the output of the power factor transducer is DC 4-20mA,

- ① Connect the output to the input terminal 5 (+), 7 (-) of this unit, then set input range[r-nr] as 4-20.
- ② When setting the input range as 4-20, L-rG is set as 400 and H-rG is set as 20000 automatically. L-rG and H-rG is for the setting of the power factor transducer output.
- ③ If measured input is 4mA, it displays -0.50. For 12mA measured input, it displays 1.00 and for 20mA, it displays 0.50.

E.g. 2) When the output of the power factor transducer is DC1-5V,

- ① Connect the output to the input terminal 5 (+), 7 (-) of this unit, then set the input range[r-nr] as 10u.
- ② Select minus input display function[r-nU] as oFF not to display minus value.
- ③ Set H-rG as 500 and L-rG as 100 for the output of the power factor transducer.
- ④ If measured input is 1V, it displays -0.50. For 3V measured input, it displays 1.00 and for 5V, it displays 0.50.

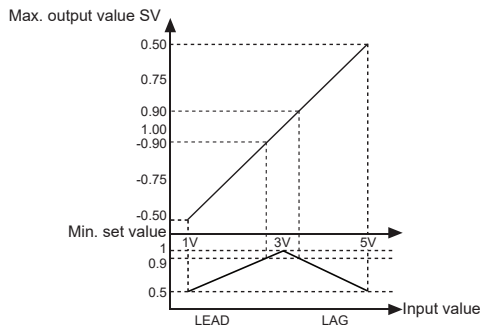

E.g. 3) When LEAD value is smaller than -0.90, LAG value is smaller than 0.90, and OUT1 is used,

- ① Set oU Lt as HL at parameter 2 group.
 - ② Set oU H as 0.90 and oU L as -0.90 at parameter 0 group.
- ※oU Lt is also same setting as oU Lt.

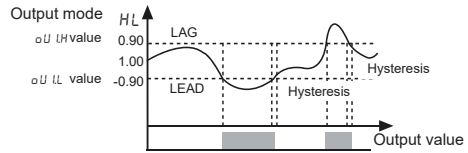

◎ Display scale [PA 1 group: H-5C / L-5C]

This function is to display setting (-1999 to 9999) of particular High/Low-limit value in order to display High/Low-limit value of measurement input. If measurement inputs are 'a' and 'b' and particular values are 'A' and 'B', it will display a=A, b=B as below graphs.

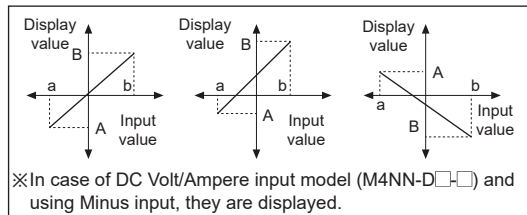
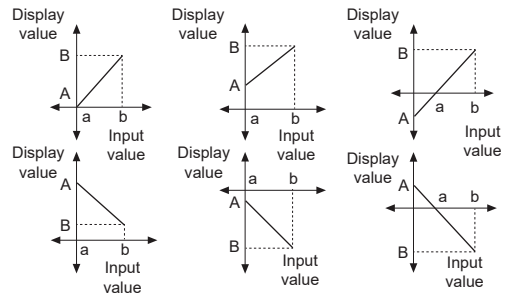

Display scale function is able to change display value for min./max. measured input by setting high limit scale H-5C, and low limit scale L-5C in parameter 1 group.

E.g.) High limit scale value and low limit scale value setting (input range = 0 to 10V)

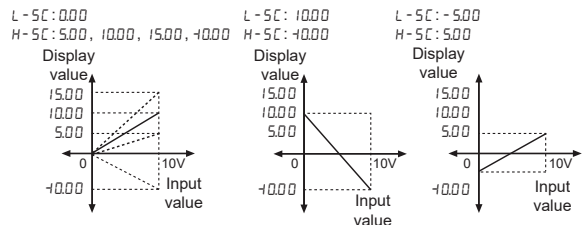

※When changing measured input, high limit scale value and low limit scale value are automatically changed as the default display range of the changed measured input.

◎ Preset output mode [PA 2 group: $\alpha U 1L / \alpha U 2L$]

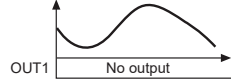
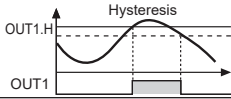
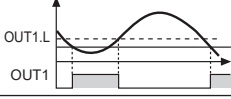
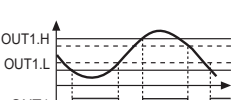
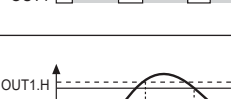
Mode	Output mode	Operation
OFF		No output
HI		Period ON : Display value $\geq \alpha U 1H$ Period OFF : Display value $\leq \alpha U 1H - HYS.1$
LO		Period ON : Display value $\leq \alpha U 1L$ Period OFF : Display value $\geq \alpha U 1L + HYS.1$
HL		Period ON : Display value $\leq \alpha U 1L$ or Display value $\geq \alpha U 1H$ Period OFF : Display value $\geq \alpha U 1L + HYS.1$ or Display value $\leq \alpha U 1H - HYS.1$
HL-G		Period ON : Display value $\geq \alpha U 1L$ or Display value $\leq \alpha U 1H$ Period OFF : Display value $\leq \alpha U 1H - HYS.1$ or Display value $\geq \alpha U 1H + HYS.1$

- ※Set output mode separately for each OUT1/OUT2.
- ※OUT1/OUT2 are operated individually depending on output operation mode.
- ※Setting value mode of parameter group 0 is displayed depending on output operation mode.
- ※GO outputs when the period both OUT1/OUT2 are off.
(NPN/PNP open collector output type)

SENSORS
CONTROLLERS
MOTION DEVICES
SOFTWARE

(J) Temperature Controllers
(K) SSRs
(L) Power Controllers
(M) Counters
(N) Timers
(O) Digital Panel Meters
(P) Indicators
(Q) Converters
(R) Digital Display Units
(S) Sensor Controllers
(T) Switching Mode Power Supplies
(U) Recorders
(V) HMIs
(W) Panel PC
(X) Field Network Devices