

## Full Metal, Cylindrical, Cable Connector Type Proximity Sensor

### ■ Features

- High impact and wear resistance to friction with the work or metallic brush (sensing face/housing material: stainless steel)
- Reduced possibility of malfunction by aluminum scraps
- Excellent noise immunity with specialized sensor IC
- Built-in surge protection circuit and output short over current protection circuit
- Excellent visibility with a 360° ring type of indicator (red LED) (except for PRFWT08 model)
- Equipped with the oil resistant cable
- Protection structure: IP67 (IEC standard)



**⚠ Please read "Safety Considerations" in the instruction manual before using.**



### ■ Durability Test

High resistance to the impact of removing Welding sludge attached to the sensing face

#### ◎ Continuous hitting test

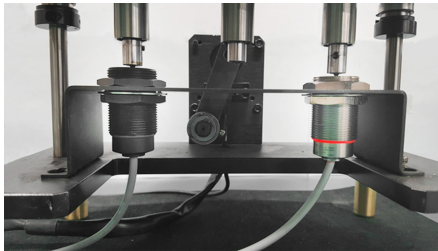

#### Test conditions

Hitting object: 1.3kg of weight  
 Hitting speed: 48 times per 1 min  
 The number of hitting times: 300 thousand times  
 Test model: PRFW18

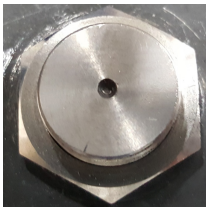

<Test result>

#### ◎ Metallic brush test



#### Test conditions

Testing object: stainless cup brush  
 Rotation speed: 80RPM  
 Testing time: 3 hours  
 Test model: PRFW18



<Test result>

### ■ Electromagnetic Resistance Test

Large current from welding generates magnetic field which can affect the proximity sensor to malfunction due to noise. This product, however, can be used near strong noise without malfunctioning, thanks to excellent electromagnetic resistance. This test is conducted in the environment of welding.

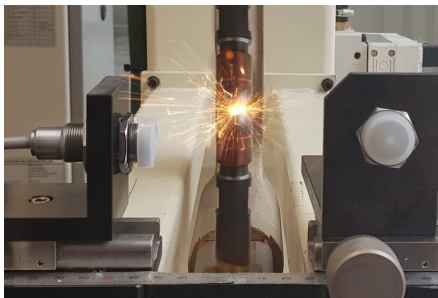

#### Test conditions

Welding current: 13,000A  
 Installation direction: front and side  
 Test model: PRFW Series

Diameter of sensing side	Minimum sensing distance between weld and sensor	
	Front	Side
8mm	60mm	70mm
12mm	30mm	60mm
18mm	10mm	50mm
30mm	120mm	120mm

※Minimum sensing distance can be different by welding environment.

※When using PRFW Series in the environment of welding, use the spatter-resistant protection cover. The protection cover is sold separately. Refer to the 'Proper Usage' in (F) Proximity Sensors for usage of the protection cover.

SENSORS

CONTROLLERS

MOTION DEVICES

SOFTWARE

(A) Photoelectric Sensors

(B) Fiber Optic Sensors

(C) LIDAR

(D) Door/Area Sensors

(E) Vision Sensors

(F) Proximity Sensors

(G) Pressure Sensors

(H) Rotary Encoders

(I) Connectors/  
Connector Cables/  
Sensor Distribution  
Boxes/ Sockets

# PRFW Series

## ■ Effect of Aluminum Scraps

When aluminum scraps are attached or stacked at sensing side, the proximity sensor does not detect and sensing signal is OFF. However, the below cases may occur to sensing signal. In this case, remove the scraps.

- (1) When the size of aluminum scraps (d) is bigger than 2/3 of the sensing side size (D)
- (2) When aluminum scraps are attached on the sensing side by external pressure

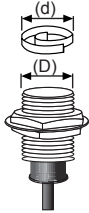

Model	Size D (mm)
PRFWT08	6
PRFWT12	10
PRFWT18	16
PRFWT30	28



## ■ Specifications

### ● DC 2-wire type

Model	PRFWT08-1.5DO-IV	PRFWT12-2DO-IV	PRFWT18-5DO-IV	PRFWT30-10DO-IV
Diameter of sensing side	8mm	12mm	18mm	30mm
Sensing distance <sup>※1</sup>	1.5mm	2mm	5mm	10mm
Installation	Shield (flush)			
Hysteresis	Max. 15% of sensing distance			
Standard sensing target	8×8×1mm (iron)	12×12×1mm (iron)	30×30×1mm (iron)	54×54×1mm (iron)
Setting distance	0 to 1.05mm	0 to 1.4mm	0 to 3.5mm	0 to 7mm
Power supply (operating voltage)	12-24VDC= (10-30VDC=)			
Leakage current	Max. 0.8mA			
Response frequency <sup>※2</sup>	200Hz	100Hz	80Hz	50Hz
Residual voltage	Max. 3.5V			
Affection by Temp.	Max. ±20% for sensing distance at ambient temperature 20°C			
Control output	Max. 3 to 100mA			
Insulation resistance	Over 50MΩ (at 500VDC megger)			
Dielectric strength	1,000VAC 50/60Hz for 1 min			
Vibration	1.5mm amplitude at frequency 10 to 55Hz (for 1 min) in each X, Y, Z direction for 2 hours			
Shock	500m/s <sup>2</sup> (approx. 50G) in each X, Y, Z direction for 10 times	1,000m/s <sup>2</sup> (approx. 100G) in each X, Y, Z direction for 10 times		
Indicator	Operation indicator: Red LED			
Environ-ment	Ambient temperature	-25 to 70°C, storage: -25 to 70°C		
	Ambient humidity	35 to 95%RH, storage: 35 to 95%RH		
Protection circuit	Surge protection circuit, output short over current protection circuit			
Protection	IP67 (IEC standard)			
Cable <sup>※3</sup>	Ø4mm, 2-wire, 300mm, M12 connector		Ø5mm, 2-wire, 300mm, M12 connector	
	AWG22, core diameter: 0.08mm, no. of cores: 60, insulator diameter: Ø1.25mm			
Material	Case/Nut: Stainless steel 303 (SUS303), Washer: Stainless steel 304 (SUS304), Sensing side: Stainless steel 303 (SUS303, thickness is 0.8mm, in case of PRFWT08 is 0.4mm), Oil resistant cable (gray): Oil resistant polyvinyl chloride (PVC)			
Approval	CE			
Weight <sup>※4</sup>	Approx. 80g (approx. 55g)	Approx. 110g (approx. 83g)	Approx. 132g (approx. 97g)	Approx. 225g (approx. 170g)

※1: Use accessories (nut, washer) made of SUS. Or, sensing distance cannot be guaranteed.

※2: The response frequency is the average value. The standard sensing target is used and the width is set as 2 times of the standard sensing target, 1/2 of the sensing distance for the distance.

※3: Do not pull the Ø4mm cable with a tensile strength of 30N or over and the Ø5mm cable with a tensile strength of 50N or over. It may result in fire due to the broken wire. When extending wire, use AWG22 cable or over within 200m.

※4: The weight includes packaging. The weight in parenthesis is for unit only.

※Environment resistance is rated at no freezing or condensation.

# Full Metal, Cylindrical, Cable Connector Type

## ■ Dimensions

(unit: mm)

### ● PRFWT08-1.5DO-IV

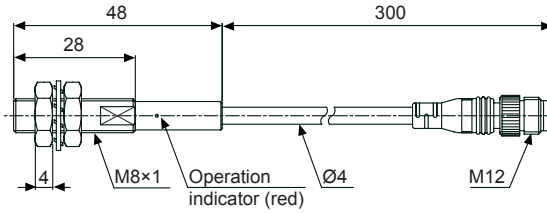
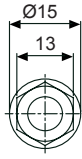

### ● PRFWT12-2DO-IV

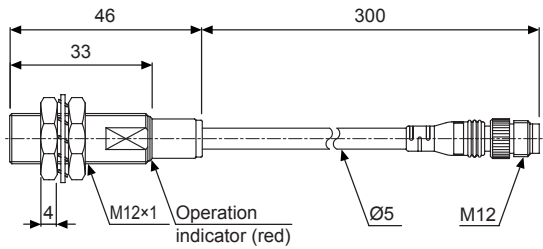
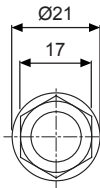

### ● PRFWT18-5DO-IV

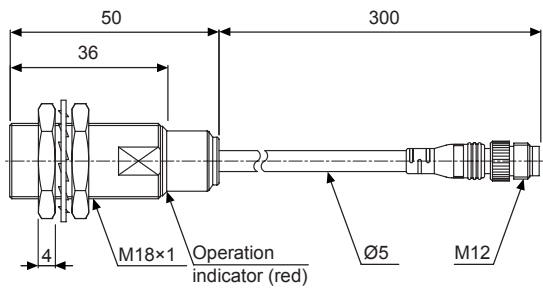
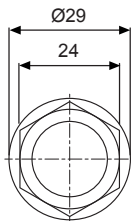

### ● PRFWT30-10DO-IV

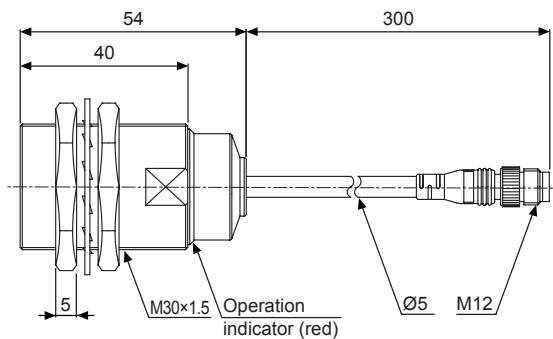
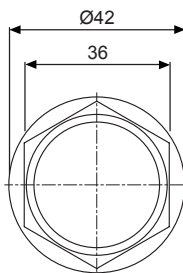

SENSORS

CONTROLLERS

MOTION DEVICES

SOFTWARE

(A) Photoelectric Sensors

(B) Fiber Optic Sensors

(C) LIDAR

(D) Door/Area Sensors

(E) Vision Sensors

(F) Proximity Sensors

(G) Pressure Sensors

(H) Rotary Encoders

(I) Connectors/  
Connector Cables/  
Sensor Distribution  
Boxes/ Sockets

# PRFW Series

## ■ Control Output Diagram & Load Operating

### ● DC 2-wire type

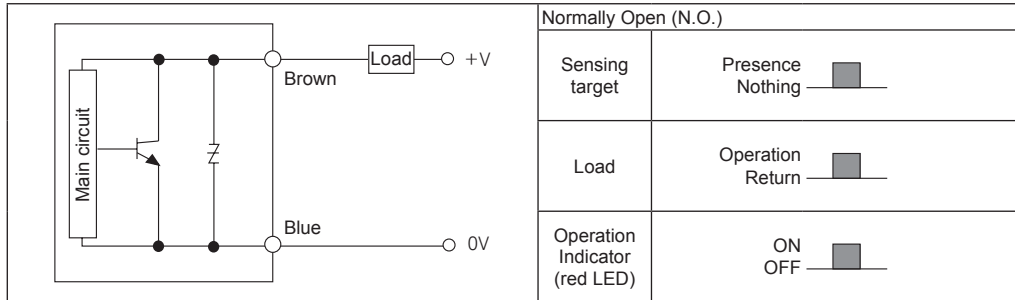

## ■ Connections

### ● DC 2-wire type (IEC standard)

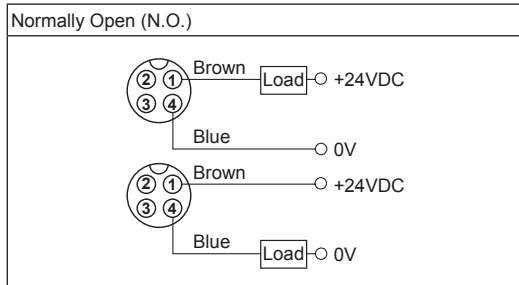

※②, ③ are N·C (Not Connected) terminals.

※For more information about cable and specification, refer to the (I) Connectors/Cable Connectors/Sensor Distribution Boxes/Sockets

# Full Metal, Cylindrical, Cable Connector Type

## ■ Sensing Distance Feature Data by Target Material and Size

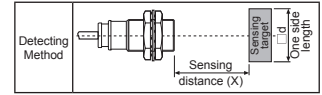

### ● PRFWT8-1.5DO-IV

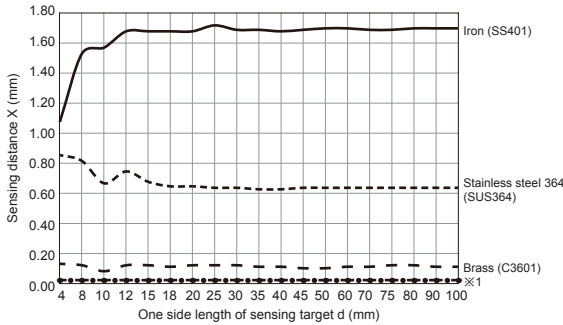

※1: Aluminum(ALS052), Copper(C1100)

### ● PRFWT12-2DO-IV

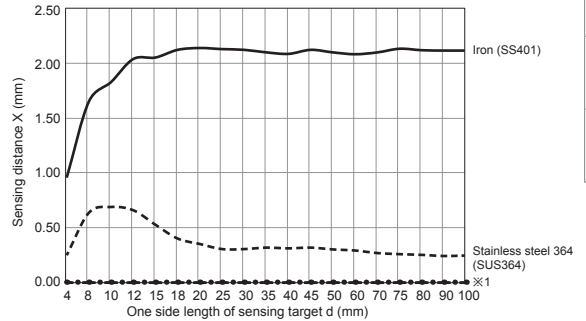

※1: Brass(C3601), Aluminum(ALS052), Copper(C1100)

### ● PRFWT18-5DO-IV

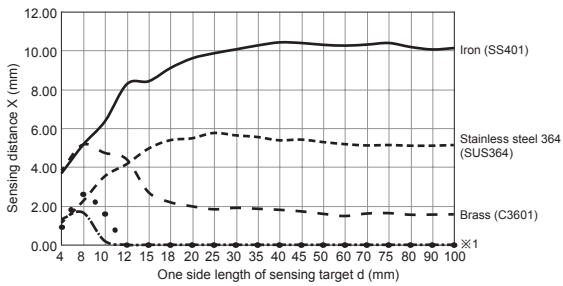

※1: Aluminum(ALS052), Copper(C1100)

### ● PRFWT30-10DO-IV

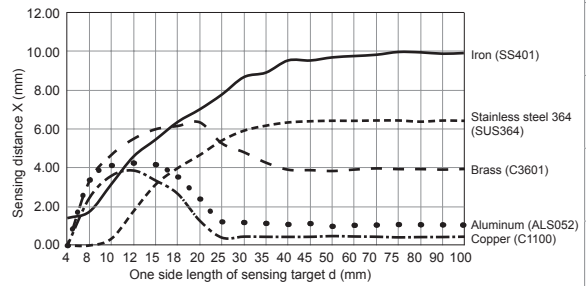

## ■ Sensing Distance Feature Data by Parallel (Left/Right) Movement

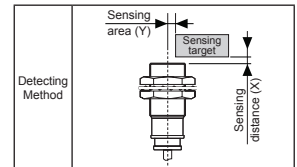

### ● PRFWT80-1.5DO-IV

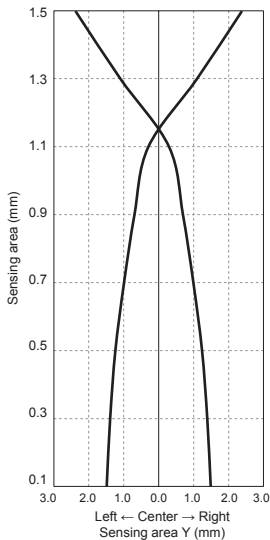

### ● PRFWT12-2DO-IV

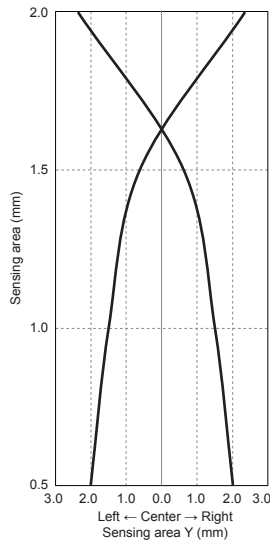

### ● PRFWT18-5DO-IV

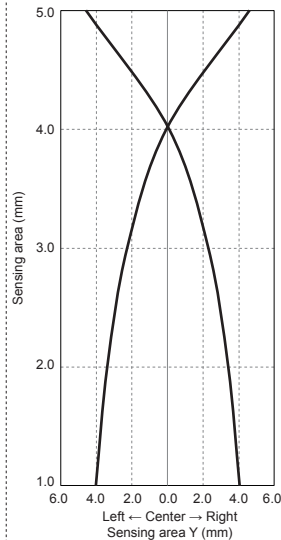

### ● PRFWT30-10DO-IV

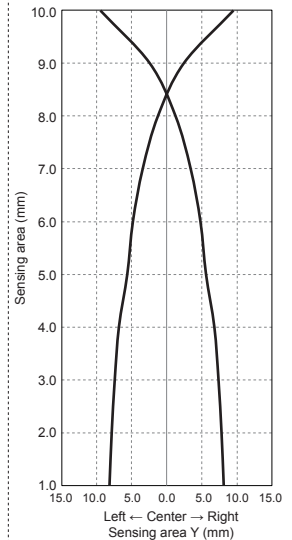

SENSORS

CONTROLLERS

MOTION DEVICES

SOFTWARE

(A) Photoelectric Sensors

(B) Fiber Optic Sensors

(C) LIDAR

(D) Door/Area Sensors

(E) Vision Sensors

(F) Proximity Sensors

(G) Pressure Sensors

(H) Rotary Encoders

(I) Connectors/  
Connector Cables/  
Sensor Distribution  
Boxes/ Sockets

# PRFW Series

## ■ Proper Usage

### ◎ Load connections

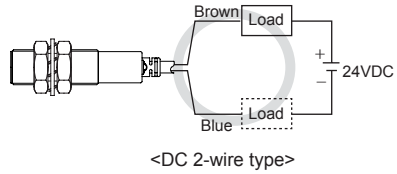
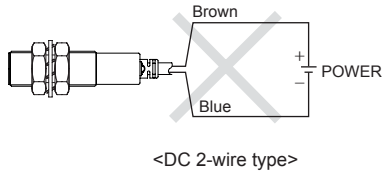

When using DC 2-wire type proximity sensor, the load must be connected, otherwise internal components may be damaged. The load can be connected to either wire.

### ◎ In case of the load current is small

#### ● DC 2-wire type

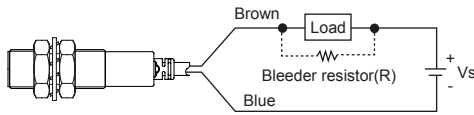

$$R \leq \frac{V_s}{I_{o-off}} \text{ (k}\Omega\text{)} \quad P > \frac{V_s^2}{R} \text{ (W)}$$

[ Vs: Power supply, I<sub>o</sub>: Min. action current of proximity sensor, I<sub>off</sub>: Return current of load, P: Number of Bleeder resistance watt ]

Please make the current on proximity sensor smaller than the return current of load by connecting a bleeder resistor in parallel.

※W value of Bleeder resistor should be bigger for proper heat dissipation.

### ◎ Mutual-interference & Influence by surrounding metals

When several proximity sensors are mounted close to one another a malfunction of the may be caused due to mutual interference. Therefore, be sure to keep a minimum distance between the two sensors as below chart indicates.

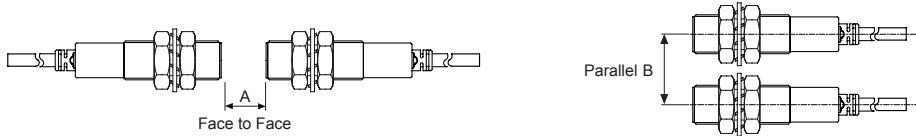

When sensors are mounted on metallic panel, it is required to protect the sensors from being affected by any metallic object except target. Therefore, be sure to provide a minimum distance as below chart indicates.

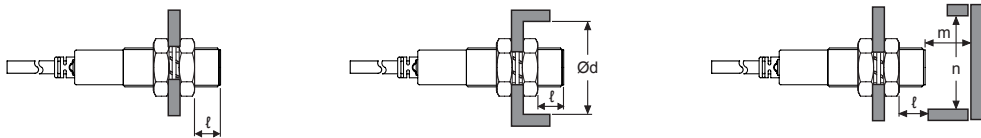

(unit: mm)

Item \ Model	PRFWT08-1.5DO-IV	PRFWT12-2DO-IV	PRFWT18-5DO-IV	PRFWT30-10DO-IV
A	35	40	65	110
B	30	35	60	100
l	0	0	0	0
Ød	8	12	18	30
m	4.5	8	20	40
n	30	40	60	100