



### Main

Range of product	Modicon M221
Product or component type	Logic controller
[Us] rated supply voltage	100...240 V AC
Discrete input number	14, discrete input conforming to IEC 61131-2 Type 1
Analogue input number	2 at 0...10 V
Discrete output type	Relay normally open
Discrete output number	10 relay
Discrete output voltage	5...125 V DC 5...250 V AC
Discrete output current	2 A

### Complementary

Discrete I/O number	24
Maximum number of I/O expansion module	7 for transistor output 7 for relay output
Supply voltage limits	85...264 V
Network frequency	50/60 Hz
Inrush current	40 A
Maximum power consumption in VA	55 VA at 100...240 V with max number of I/O expansion module 32 VA at 100...240 V without I/O expansion module
Power supply output current	0.52 A 5 V for expansion bus 0.16 A 24 V for expansion bus
Discrete input logic	Sink or source (positive/negative)
Discrete input voltage	24 V
Discrete input voltage type	DC
Analogue input resolution	10 bits
LSB value	10 mV
Conversion time	1 ms per channel + 1 controller cycle time for analogue input analog input
Permitted overload on inputs	+/- 30 V DC for 5 min (maximum) for analog input

Disclaimer: This documentation is not intended as a substitute for and is not to be used for determining suitability or reliability of these products for specific user applications

	+/- 13 V DC (permanent) for analog input
Voltage state 1 guaranteed	>= 15 V for input
Voltage state 0 guaranteed	<= 5 V for input
Discrete input current	7 mA for discrete input 5 mA for fast input
Input impedance	3.4 kOhm for discrete input 100 kOhm for analog input 4.9 kOhm for fast input
Response time	35 µs turn-off, I2...I5 terminal(s) for input 10 ms turn-on for output 10 ms turn-off for output 5 µs turn-on, I0, I1, I6, I7 terminal(s) for fast input 35 µs turn-on, other terminals terminal(s) for input 5 µs turn-off, I0, I1, I6, I7 terminal(s) for fast input 100 µs turn-off, other terminals terminal(s) for input
Configurable filtering time	0 ms for input 3 ms for input 12 ms for input
Output voltage limits	125 V DC 277 V AC
Maximum current per output common	4 A at COM 2 7 A at COM 0 7 A at COM 1
Absolute accuracy error	+/- 1 % of full scale for analog input
Electrical durability	100000 cycles AC-12, 120 V, 240 VA, resistive 100000 cycles AC-12, 240 V, 480 VA, resistive 300000 cycles AC-12, 120 V, 80 VA, resistive 300000 cycles AC-12, 240 V, 160 VA, resistive 100000 cycles AC-15, cos phi = 0.35, 120 V, 60 VA, inductive 100000 cycles AC-15, cos phi = 0.35, 240 V, 120 VA, inductive 300000 cycles AC-15, cos phi = 0.35, 120 V, 18 VA, inductive 300000 cycles AC-15, cos phi = 0.35, 240 V, 36 VA, inductive 100000 cycles AC-14, cos phi = 0.7, 120 V, 120 VA, inductive 100000 cycles AC-14, cos phi = 0.7, 240 V, 240 VA, inductive 300000 cycles AC-14, cos phi = 0.7, 120 V, 36 VA, inductive 300000 cycles AC-14, cos phi = 0.7, 240 V, 72 VA, inductive 100000 cycles DC-12, 24 V, 48 W, resistive 300000 cycles DC-12, 24 V, 16 W, resistive 100000 cycles DC-13, 24 V, 24 W, inductive (L/R = 7 ms) 300000 cycles DC-13, 24 V, 7.2 W, inductive (L/R = 7 ms)
Switching frequency	20 switching operations/minute with maximum load
Mechanical durability	20000000 cycles for relay output
Minimum load	1 mA at 5 V DC for relay output
Protection type	Without protection at 5 A
Reset time	1 s
Memory capacity	256 kB for user application and data RAM with 10000 instructions 256 kB for internal variables RAM
Data backed up	256 kB built-in flash memory for backup of application and data
Data storage equipment	2 GB SD card (optional)
Battery type	BR2032 lithium non-rechargeable, battery life: 4 year(s)
Backup time	1 year at 25 °C (by interruption of power supply)
Execution time for 1 KInstruction	0.3 ms for event and periodic task
Execution time per instruction	0.2 µs Boolean
Exct time for event task	60 µs response time
Maximum size of object areas	255 %C counters 8000 %MW memory words 512 %M memory bits 512 %KW constant words 255 %TM timers
Realtime clock	With
Clock drift	<= 30 s/month at 25 °C
Regulation loop	Adjustable PID regulator up to 14 simultaneous loops
Counting input number	4 fast input (HSC mode) at 100 kHz 32 bits

Counter function	A/B Single phase Pulse/direction
Integrated connection type	USB port with mini B USB 2.0 connector Non isolated serial link serial 1 with RJ45 connector and RS485 interface Non isolated serial link serial 2 with RJ45 connector and RS232/RS485 interface
Supply	(serial)serial link supply: 5 V, <200 mA
Transmission rate	1.2...115.2 kbit/s (115.2 kbit/s by default) for bus length of 15 m for RS485 1.2...115.2 kbit/s (115.2 kbit/s by default) for bus length of 3 m for RS232 480 Mbit/s for USB
Communication port protocol	USB port: USB - SoMachine-Network Non isolated serial link: Modbus master/slave - RTU/ASCII or SoMachine-Network
Local signalling	1 LED (green)PWR: 1 LED (green)RUN: 1 LED (red)module error (ERR): 1 LED (green)SD card access (SD): 1 LED (red)BAT: 1 LED (green)SL1: 1 LED (green)SL2: 1 LED per channel (green)I/O state:
Electrical connection	removable screw terminal block for inputs removable screw terminal block for outputs terminal block, 3 terminal(s) for connecting the 24 V DC power supply connector, 4 terminal(s) for analogue inputs Mini B USB 2.0 connector for a programming terminal
Maximum cable distance between devices	Shielded cable: <10 m for fast input Unshielded cable: <30 m for output Unshielded cable: <30 m for digital input Unshielded cable: <1 m for analog input
Insulation	Between input and internal logic at 500 V AC Non-insulated between analogue input and internal logic Non-insulated between analogue inputs Between supply and ground at 1500 V AC Between sensor power supply and ground at 500 V AC Between input and ground at 500 V AC Between output and ground at 1500 V AC Between supply and internal logic at 2300 V AC Between sensor power supply and internal logic at 500 V AC Between output and internal logic at 2300 V AC Between Ethernet terminal and internal logic at 500 V AC Between supply and sensor power supply at 2300 V AC
Marking	CE
Sensor power supply	24 V DC at 250 mA supplied by the controller
Mounting support	Top hat type TH35-15 rail conforming to IEC 60715 Top hat type TH35-7.5 rail conforming to IEC 60715 plate or panel with fixing kit
Height	90 mm
Depth	70 mm
Width	110 mm
Net weight	0.395 kg

## Environment

Standards	EN/IEC 61010-2-201 EN/IEC 60664-1 EN/IEC 61131-2
Product certifications	CSA LR ABS IACS E10 DNV-GL RCM CULus EAC
Environmental characteristic	Ordinary and hazardous location
Resistance to electrostatic discharge	8 kV in air conforming to EN/IEC 61000-4-2 4 kV on contact conforming to EN/IEC 61000-4-2

Resistance to electromagnetic fields	10 V/m 80 MHz...1 GHz conforming to EN/IEC 61000-4-3 3 V/m 1.4 GHz...2 GHz conforming to EN/IEC 61000-4-3 1 V/m 2...2.7 GHz conforming to EN/IEC 61000-4-3
Resistance to magnetic fields	30 A/m 50/60 Hz conforming to EN/IEC 61000-4-8
Resistance to fast transients	2 kV (power lines) conforming to EN/IEC 61000-4-4 2 kV (relay output) conforming to EN/IEC 61000-4-4 1 kV (I/O) conforming to EN/IEC 61000-4-4 1 kV (Ethernet line) conforming to EN/IEC 61000-4-4 1 kV (serial link) conforming to EN/IEC 61000-4-4
Surge withstand	2 kV power lines (AC) common mode conforming to EN/IEC 61000-4-5 2 kV relay output common mode conforming to EN/IEC 61000-4-5 1 kV I/O common mode conforming to EN/IEC 61000-4-5 1 kV shielded cable common mode conforming to EN/IEC 61000-4-5 0.5 kV power lines (DC) differential mode conforming to EN/IEC 61000-4-5 1 kV power lines (AC) differential mode conforming to EN/IEC 61000-4-5 1 kV relay output differential mode conforming to EN/IEC 61000-4-5 0.5 kV power lines (DC) common mode conforming to EN/IEC 61000-4-5
Resistance to conducted disturbances	10 V 0.15...80 MHz conforming to EN/IEC 61000-4-6 3 V 0.1...80 MHz conforming to Marine specification (LR, ABS, DNV, GL) 10 V spot frequency (2, 3, 4, 6.2, 8.2, 12.6, 16.5, 18.8, 22, 25 MHz) conforming to Marine specification (LR, ABS, DNV, GL)
Electromagnetic emission	Conducted emissions - test level: 79 dB $\mu$ V/m QP/66 dB $\mu$ V/m AV ( power lines (AC)) at 0.15...0.5 MHz conforming to EN/IEC 55011 Conducted emissions - test level: 73 dB $\mu$ V/m QP/60 dB $\mu$ V/m AV ( power lines (AC)) at 0.5...300 MHz conforming to EN/IEC 55011 Conducted emissions - test level: 120...69 dB $\mu$ V/m QP ( power lines) at 10...150 kHz conforming to EN/IEC 55011 Conducted emissions - test level: 63 dB $\mu$ V/m QP ( power lines) at 1.5...30 MHz conforming to EN/IEC 55011 Radiated emissions - test level: 40 dB $\mu$ V/m QP class A ( 10 m) at 30...230 MHz conforming to EN/IEC 55011 Conducted emissions - test level: 79...63 dB $\mu$ V/m QP ( power lines) at 150...1500 kHz conforming to EN/IEC 55011 Radiated emissions - test level: 47 dB $\mu$ V/m QP class A ( 10 m) at 200...1000 MHz conforming to EN/IEC 55011
Immunity to microbreaks	10 ms
Ambient air temperature for operation	-10...55 °C (horizontal installation) -10...35 °C (vertical installation)
Ambient air temperature for storage	-25...70 °C
Relative humidity	10...95 %, without condensation (in operation) 10...95 %, without condensation (in storage)
IP degree of protection	IP20 with protective cover in place
Pollution degree	<= 2
Operating altitude	0...2000 m
Storage altitude	0...3000 m
Vibration resistance	3.5 mm at 5...8.4 Hz on symmetrical rail 3.5 mm at 5...8.4 Hz on panel mounting 1 gn at 8.4...150 Hz on symmetrical rail 1 gn at 8.4...150 Hz on panel mounting
Shock resistance	98 m/s <sup>2</sup> for 11 ms

## Packing Units

Package 1 Weight	380.000 g
Package 1 Height	106.000 mm
Package 1 width	139.000 mm
Package 1 Length	155.000 mm

## Offer Sustainability

Sustainable offer status	Green Premium product
REACH Regulation	<a href="#">REACH Declaration</a>
EU RoHS Directive	Pro-active compliance (Product out of EU RoHS legal scope) <a href="#">EU RoHS Declaration</a>
Mercury free	Yes

RoHS exemption information	<a href="#">Yes</a>
China RoHS Regulation	<a href="#">China RoHS declaration</a>
Environmental Disclosure	<a href="#">Product Environmental Profile</a>
Circularity Profile	<a href="#">End of Life Information</a>
WEEE	The product must be disposed on European Union markets following specific waste collection and never end up in rubbish bins
PVC free	Yes

Dimensions

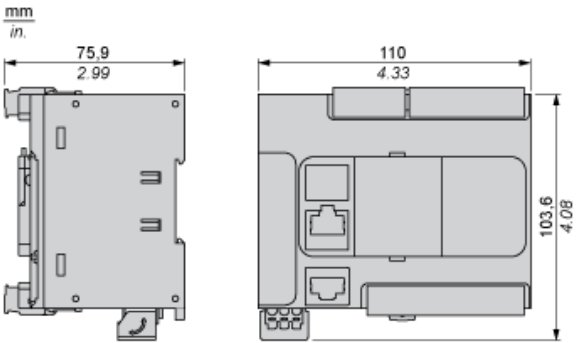

---

Mounting on a Rail

---

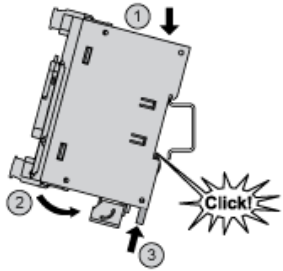

---

Direct Mounting on a Panel Surface

---

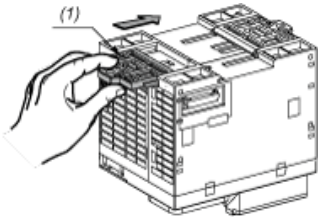

(1) Install a mounting strip

Mounting Hole Layout

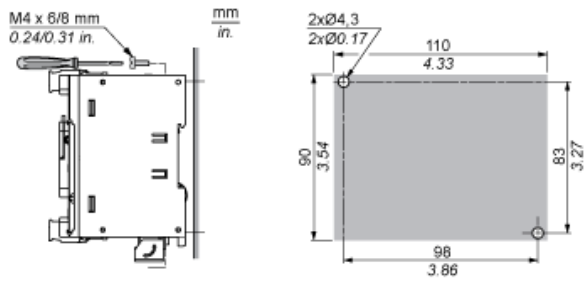



---

Mounting

---

Correct Mounting Position

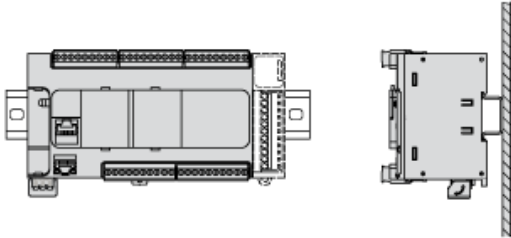

Acceptable Mounting Position

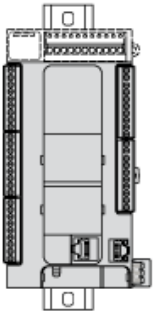

Incorrect Mounting Position

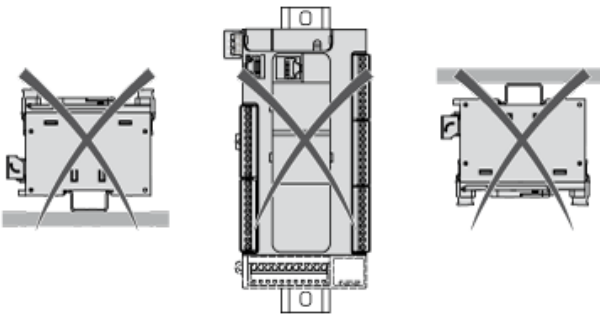

Clearance

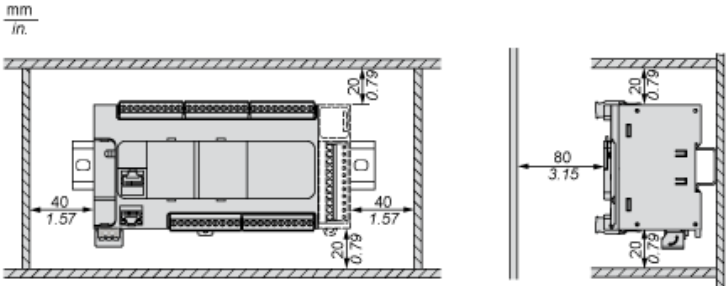

---

Digital Inputs

---

Wiring Diagram (Positive Logic)

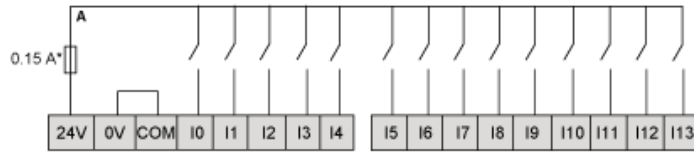

(\*) Type T fuse

Wiring Diagram (Negative Logic)

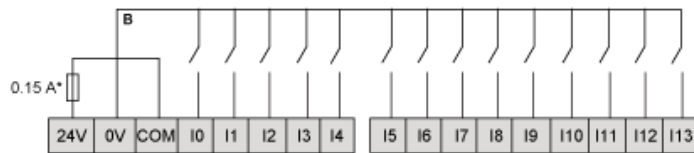

(\*) Type T fuse

Connection of the Fast Inputs

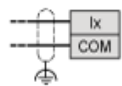

Relay Outputs

Positive Logic (Sink)

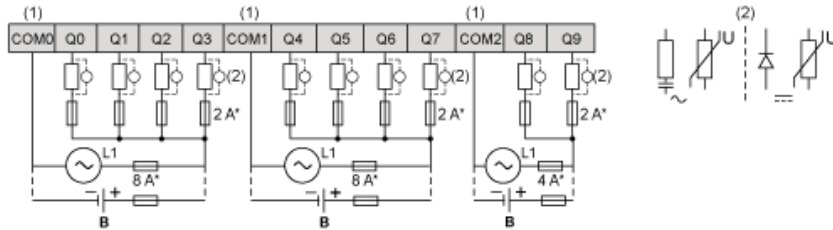

(\*) Type T fuse

(1) The COM0, COM1 and COM2 terminals are not connected internally.

(2) To improve the life time of the contacts, and to protect from potential inductive load damage, you must connect a free wheeling diode in parallel to each

Negative Logic (Source)

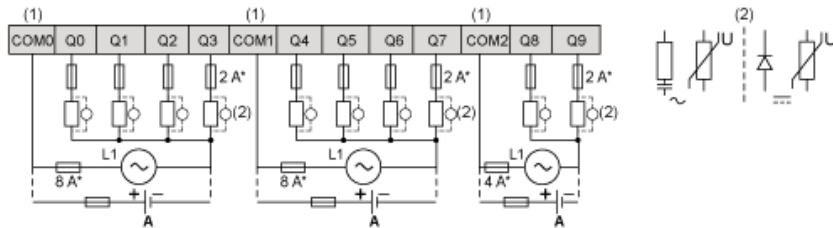

(\*) Type T fuse

(1) The COM0, COM1 and COM2 terminals are not connected internally.

(2) To improve the life time of the contacts, and to protect from potential inductive load damage, you must connect a free wheeling diode in parallel to each

Analog Inputs

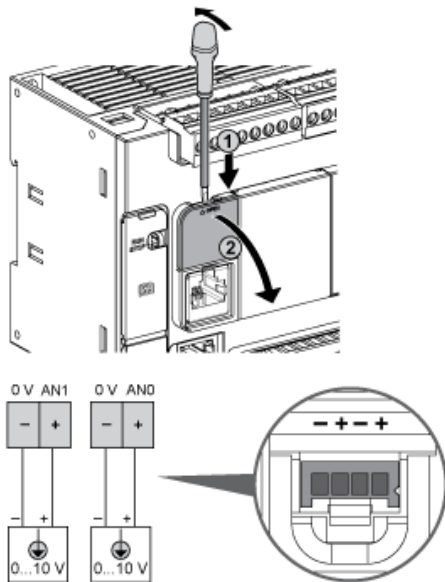

The (-) poles are connected internally.

Pin	Wire Color
0 V	Black
AN1	Red
0 V	Black
AN0	Red

---

USB Mini-B Connection

---

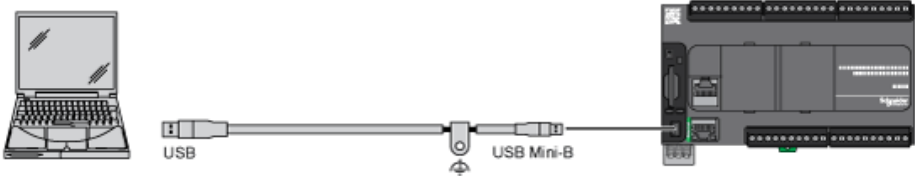

SL1 Connection

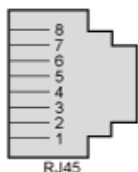

SL1

N °	RS 232	RS 485
1	RxD	N.C.
2	TxD	N.C.
3	RTS	N.C.
4	N.C.	D1 (A+)
5	N.C.	D0 (B-)
6	CTS	N.C.
7	N.C.	5 Vdc
8	Common	Common

N.C.: not connected

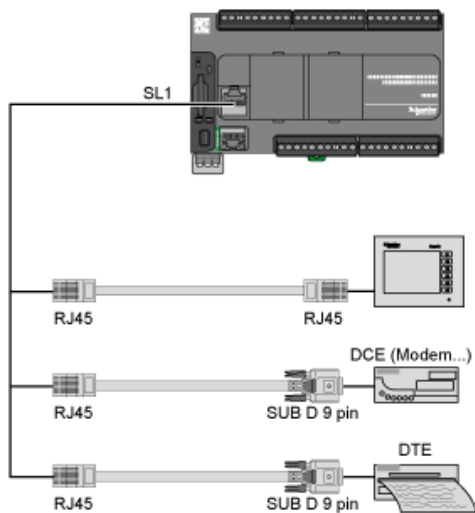

SL2 Connection

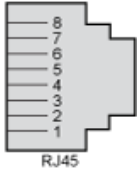

N °	RS 485
1	N.C.
2	N.C.
3	N.C.
4	D1 (A+)
5	D0 (B-)
6	N.C.
7	N.C.
8	Common

N.C.: not connected



Derating Curves

Embedded Digital Inputs (No Cartridge)

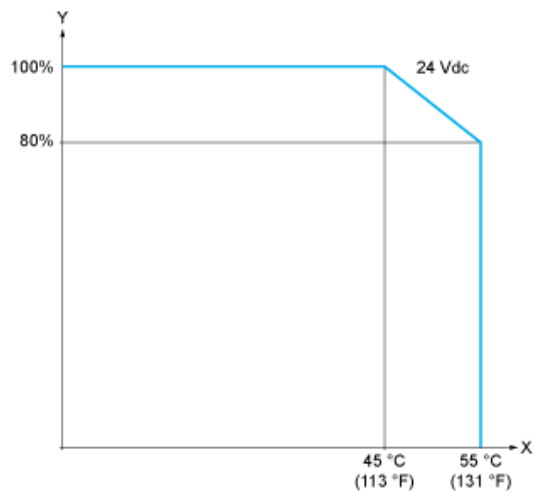

X : Ambient temperature  
Y : Input simultaneous ON ratio

Embedded Digital Inputs (with Cartridge)

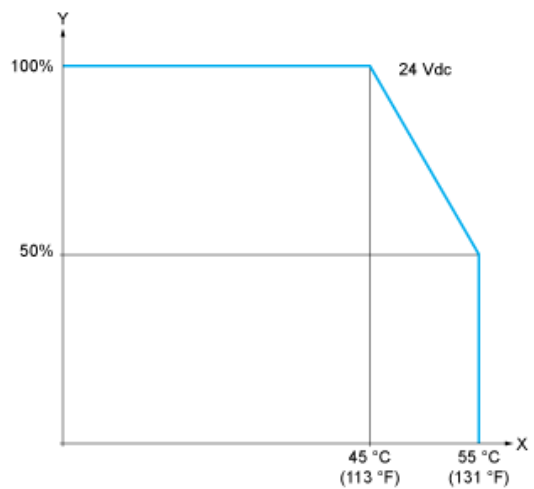

X : Ambient temperature  
Y : Input simultaneous ON ratio