



### Main

|                           |  |
|---------------------------|--|
| Range of product          | Modicon M221   |
| Product or component type | Logic controller   |
| [Us] rated supply voltage | 24 V DC  |
| Discrete input number     | 24, discrete input 4 fast input conforming to IEC 61131-2 Type 1 |
| Analogue input number     | 2 at 0...10 V  |
| Discrete output type      | Transistor   |
| Discrete output number    | 16 transistor 2 fast output                                      |
| Discrete output voltage   | 24 V DC  |
| Discrete output current   | 0.5 A  |

### Complementary

|  |  |
|--|--|
| Discrete I/O number                    | 40   |
| Maximum number of I/O expansion module | 7 for relay output   |
| Supply voltage limits                  | 20.4...28.8 V  |
| Inrush current                         | 35 A   |
| Maximum power consumption in W         | 17 W at 24 V (with max number of I/O expansion module)<br>4.9 W at 24 V (without I/O expansion module) |
| Power supply output current            | 0.52 A 5 V for expansion bus<br>0.3 A 24 V for expansion bus   |
| Discrete input logic                   | Sink or source (positive/negative)   |
| Discrete input voltage                 | 24 V   |
| Discrete input voltage type            | DC   |
| Analogue input resolution              | 10 bits  |
| LSB value                              | 10 mV  |
| Conversion time                        | 1 ms per channel + 1 controller cycle time for analogue input analog input                             |
| Permitted overload on inputs           | +/- 30 V DC for 5 min (maximum) for analog input<br>+/- 13 V DC (permanent) for analog input           |
| Voltage state 1 guaranteed             | >= 15 V for input  |

Disclaimer: This documentation is not intended as a substitute for and is not to be used for determining suitability or reliability of these products for specific user applications

|                                   |   |
|-----------------------------------|---|
| Voltage state 0 guaranteed        | <= 5 V for input  |
| Discrete input current            | 7 mA for discrete input<br>5 mA for fast input  |
| Input impedance                   | 3.4 kOhm for discrete input<br>100 kOhm for analog input<br>4.9 kOhm for fast input   |
| Response time                     | 35 µs turn-off, I2...I5 terminal(s) for input<br>5 µs turn-on, I0, I1, I6, I7 terminal(s) for fast input<br>35 µs turn-on, other terminals terminal(s) for input<br>5 µs turn-off, I0, I1, I6, I7 terminal(s) for fast input<br>100 µs turn-off, other terminals terminal(s) for input<br>5 µs turn-on, turn-off, Q0...Q1 terminal(s) for output<br>50 µs turn-on, turn-off, Q2...Q3 terminal(s) for output<br>300 µs turn-on, turn-off, other terminals terminal(s) for output |
| Configurable filtering time       | 0 ms for input<br>3 ms for input<br>12 ms for input   |
| Discrete output logic             | Positive logic (source)   |
| Maximum current per output common | 4 A   |
| Output frequency                  | 100 kHz for fast output (PWM/PLS mode) at Q0...Q1<br>5 kHz for output at Q2...Q3<br>0.1 kHz for output at Q4...Q15  |
| Absolute accuracy error           | +/- 1 % of full scale for analog input  |
| Maximum leakage current           | 0.1 mA for transistor output  |
| Maximum voltage drop              | <1 V  |
| Mechanical durability             | 20000000 cycles for transistor output   |
| Maximum tungsten load             | <12 W for output and fast output  |
| Protection type                   | Overload and short-circuit protection at 1 A  |
| Reset time                        | 1 s automatic reset   |
| Memory capacity                   | 256 kB for user application and data RAM with 10000 instructions<br>256 kB for internal variables RAM   |
| Data backed up                    | 256 kB built-in flash memory for backup of application and data   |
| Data storage equipment            | 2 GB SD card (optional)   |
| Battery type                      | BR2032 lithium non-rechargeable, battery life: 4 year(s)  |
| Backup time                       | 1 year at 25 °C (by interruption of power supply)   |
| Execution time for 1 KInstruction | 0.3 ms for event and periodic task  |
| Execution time per instruction    | 0.2 µs Boolean  |
| Exct time for event task          | 60 µs response time   |
| Maximum size of object areas      | 512 %KW constant words<br>255 %TM timers<br>255 %C counters<br>8000 %MW memory words<br>512 %M memory bits  |
| Realtime clock                    | With  |
| Clock drift                       | <= 30 s/month at 25 °C  |
| Regulation loop                   | Adjustable PID regulator up to 14 simultaneous loops  |
| Positioning functions             | Position PTO 2 axe(s)pulse/direction mode (100 kHz)<br>Position PTO 1 axe(s)CW/CCW mode (100 kHz)   |
| Function available                | PWM<br>PLS<br>Frequency generator   |
| Counting input number             | 4 fast input (HSC mode) at 100 kHz 32 bits  |
| Counter function                  | A/B<br>Pulse/direction<br>Single phase  |
| Integrated connection type        | USB port with mini B USB 2.0 connector<br>Non isolated serial link serial 1 with RJ45 connector and RS232/RS485 interface<br>Ethernet with RJ45 connector   |
| Supply                            | (serial)serial link supply: 5 V, <200 mA  |
| Transmission rate                 | 1.2...115.2 kbit/s (115.2 kbit/s by default) for bus length of 15 m for RS485<br>1.2...115.2 kbit/s (115.2 kbit/s by default) for bus length of 3 m for RS232   |

|  |   |
|--|---|
|  | 480 Mbit/s for USB  |
| Communication port protocol            | USB port: USB - SoMachine-Network<br>Non isolated serial link: Modbus master/slave - RTU/ASCII or SoMachine-Network Ethernet  |
| Port Ethernet                          | 10BASE-T/100BASE-TX 1 port with 100 m copper cable  |
| Communication service                  | Modbus TCP slave device<br>Ethernet/IP adapter<br>Modbus TCP server<br>Modbus TCP client<br>DHCP client   |
| Local signalling                       | 1 LED (green)PWR:<br>1 LED (green)RUN:<br>1 LED (red)module error (ERR):<br>1 LED (green)SD card access (SD):<br>1 LED (red)BAT:<br>1 LED per channel (green)I/O state:<br>1 LED (green)SL:<br>Ethernet network activity (green)ACT:<br>Ethernet network link (yellow)Link (Link Status): |
| Electrical connection                  | removable screw terminal block for inputs<br>removable screw terminal block for outputs<br>terminal block, 3 terminal(s) for connecting the 24 V DC power supply<br>connector, 4 terminal(s) for analogue inputs<br>Mini B USB 2.0 connector for a programming terminal                   |
| Maximum cable distance between devices | Shielded cable: <10 m for fast input<br>Unshielded cable: <30 m for output<br>Unshielded cable: <30 m for digital input<br>Unshielded cable: <1 m for analog input<br>Shielded cable: <3 m for fast output  |
| Insulation                             | Between input and internal logic at 500 V AC<br>Between fast input and internal logic at 500 V AC<br>Non-insulated between inputs<br>Between output and internal logic at 500 V AC<br>Non-insulated between analogue input and internal logic<br>Non-insulated between analogue inputs    |
| Marking                                | CE  |
| Mounting support                       | Top hat type TH35-15 rail conforming to IEC 60715<br>Top hat type TH35-7.5 rail conforming to IEC 60715<br>plate or panel with fixing kit   |
| Height                                 | 90 mm   |
| Depth                                  | 70 mm   |
| Width                                  | 160 mm  |
| Net weight                             | 0.456 kg  |

## Environment

|                                       |  |
|---------------------------------------|--|
| Standards                             | EN/IEC 60664-1<br>EN/IEC 61131-2<br>EN/IEC 61010-2-201   |
| Product certifications                | RCM<br>IACS E10<br>CSA<br>EAC<br>ABS<br>LR<br>CULus<br>DNV-GL  |
| Environmental characteristic          | Ordinary and hazardous location  |
| Resistance to electrostatic discharge | 8 kV in air conforming to EN/IEC 61000-4-2<br>4 kV on contact conforming to EN/IEC 61000-4-2   |
| Resistance to electromagnetic fields  | 10 V/m 80 MHz...1 GHz conforming to EN/IEC 61000-4-3<br>3 V/m 1.4 GHz...2 GHz conforming to EN/IEC 61000-4-3<br>1 V/m 2...2.7 GHz conforming to EN/IEC 61000-4-3 |
| Resistance to magnetic fields         | 30 A/m 50/60 Hz conforming to EN/IEC 61000-4-8   |
| Resistance to fast transients         | 2 kV (power lines) conforming to EN/IEC 61000-4-4<br>2 kV (relay output) conforming to EN/IEC 61000-4-4<br>1 kV (I/O) conforming to EN/IEC 61000-4-4             |

|                                       |  |
|---------------------------------------|--|
|                                       | 1 kV (Ethernet line) conforming to EN/IEC 61000-4-4<br>1 kV (serial link) conforming to EN/IEC 61000-4-4   |
| Surge withstand                       | 2 kV power lines (AC) common mode conforming to EN/IEC 61000-4-5<br>2 kV relay output common mode conforming to EN/IEC 61000-4-5<br>1 kV I/O common mode conforming to EN/IEC 61000-4-5<br>1 kV shielded cable common mode conforming to EN/IEC 61000-4-5<br>0.5 kV power lines (DC) differential mode conforming to EN/IEC 61000-4-5<br>1 kV power lines (AC) differential mode conforming to EN/IEC 61000-4-5<br>1 kV relay output differential mode conforming to EN/IEC 61000-4-5<br>0.5 kV power lines (DC) common mode conforming to EN/IEC 61000-4-5  |
| Resistance to conducted disturbances  | 10 V 0.15...80 MHz conforming to EN/IEC 61000-4-6<br>3 V 0.1...80 MHz conforming to Marine specification (LR, ABS, DNV, GL)<br>10 V spot frequency (2, 3, 4, 6.2, 8.2, 12.6, 16.5, 18.8, 22, 25 MHz) conforming to Marine specification (LR, ABS, DNV, GL)   |
| Electromagnetic emission              | Conducted emissions - test level: 79 dB $\mu$ V/m QP/66 dB $\mu$ V/m AV ( power lines (AC)) at 0.15...0.5 MHz conforming to EN/IEC 55011<br>Conducted emissions - test level: 73 dB $\mu$ V/m QP/60 dB $\mu$ V/m AV ( power lines (AC)) at 0.5...300 MHz conforming to EN/IEC 55011<br>Conducted emissions - test level: 120...69 dB $\mu$ V/m QP ( power lines) at 10...150 kHz conforming to EN/IEC 55011<br>Conducted emissions - test level: 63 dB $\mu$ V/m QP ( power lines) at 1.5...30 MHz conforming to EN/IEC 55011<br>Radiated emissions - test level: 40 dB $\mu$ V/m QP class A ( 10 m) at 30...230 MHz conforming to EN/IEC 55011<br>Conducted emissions - test level: 79...63 dB $\mu$ V/m QP ( power lines) at 150...1500 kHz conforming to EN/IEC 55011<br>Radiated emissions - test level: 47 dB $\mu$ V/m QP class A ( 10 m) at 200...1000 MHz conforming to EN/IEC 55011 |
| Immunity to microbreaks               | 10 ms  |
| Ambient air temperature for operation | -10...55 °C (horizontal installation)<br>-10...35 °C (vertical installation)   |
| Ambient air temperature for storage   | -25...70 °C  |
| Relative humidity                     | 10...95 %, without condensation (in operation)<br>10...95 %, without condensation (in storage)   |
| IP degree of protection               | IP20 with protective cover in place  |
| Pollution degree                      | <= 2   |
| Operating altitude                    | 0...2000 m   |
| Storage altitude                      | 0...3000 m   |
| Vibration resistance                  | 3.5 mm at 5...8.4 Hz on symmetrical rail<br>3.5 mm at 5...8.4 Hz on panel mounting<br>1 gn at 8.4...150 Hz on symmetrical rail<br>1 gn at 8.4...150 Hz on panel mounting   |
| Shock resistance                      | 147 m/s <sup>2</sup> for 11 ms   |

## Packing Units

|                  |           |
|------------------|-----------|
| Package 1 Weight | 0.766 kg  |
| Package 1 Height | 11.400 cm |
| Package 1 width  | 14.200 cm |
| Package 1 Length | 20.800 cm |

## Offer Sustainability

|                            |   |
|----------------------------|---|
| Sustainable offer status   | Green Premium product   |
| EU RoHS Directive          | Pro-active compliance (Product out of EU RoHS legal scope)<br><a href="#">EU RoHS Declaration</a>                           |
| Mercury free               | Yes   |
| RoHS exemption information | <a href="#">Yes</a>   |
| China RoHS Regulation      | <a href="#">China RoHS declaration</a>  |
| Environmental Disclosure   | <a href="#">Product Environmental Profile</a>   |
| Circularity Profile        | <a href="#">End of Life Information</a>   |
| WEEE                       | The product must be disposed on European Union markets following specific waste collection and never end up in rubbish bins |
| PVC free                   | Yes   |

Dimensions

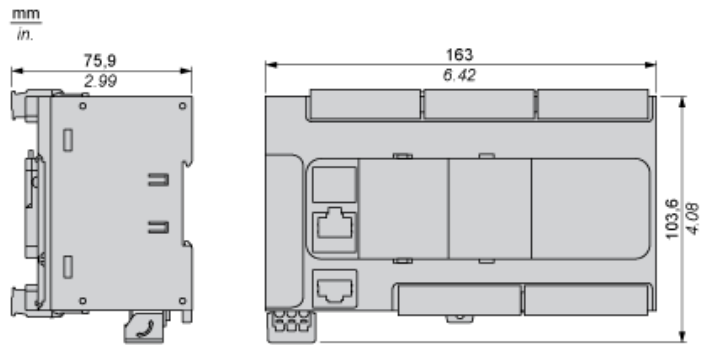

---

Mounting on a Rail

---

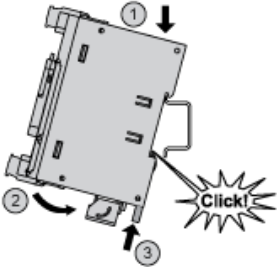

Direct Mounting on a Panel Surface

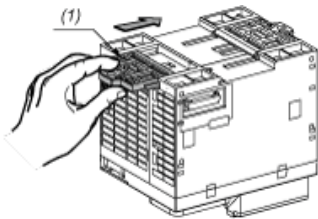

(1) Install a mounting strip

Mounting Hole Layout

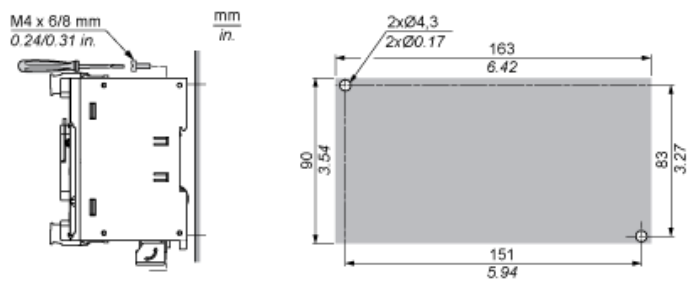

Mounting

Correct Mounting Position

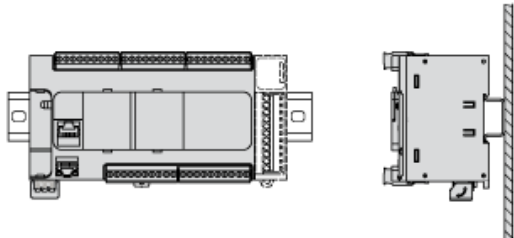

Acceptable Mounting Position

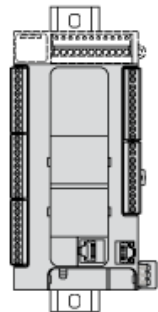

Incorrect Mounting Position

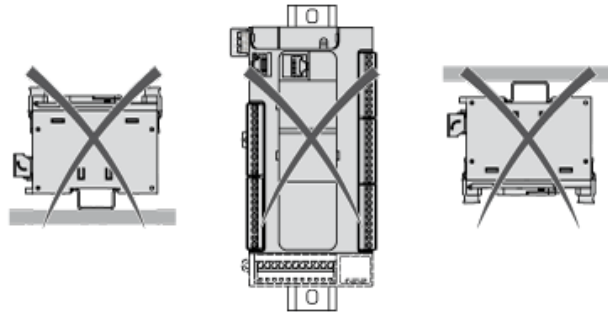



Clearance

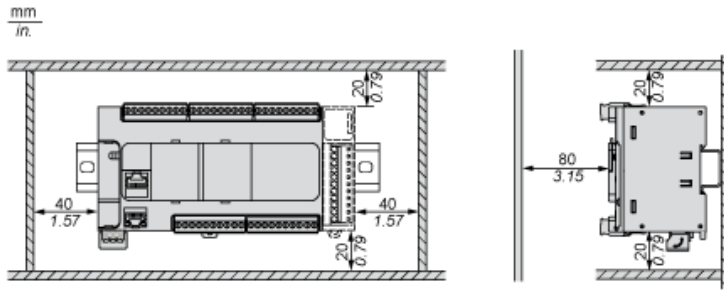

---

## Digital Inputs

---

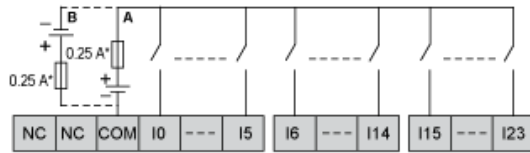

- (\*) Type T fuse
- (A) Sink wiring (positive logic).
- (B) Source wiring (negative logic).

## Connection of the Fast Inputs

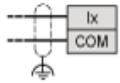

### Transistor Output

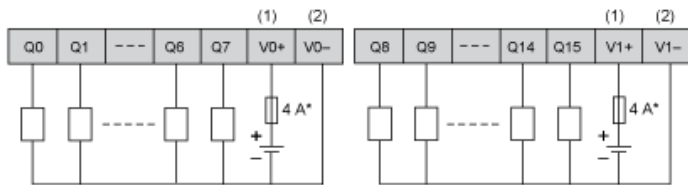

- (\*) Type T fuse
- (1) The V0+ and V1+ terminals are not connected internally.
- (2) The V0- and V1- terminals are not connected internally.

### Connection of the Fast Outputs

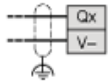

Analog Inputs

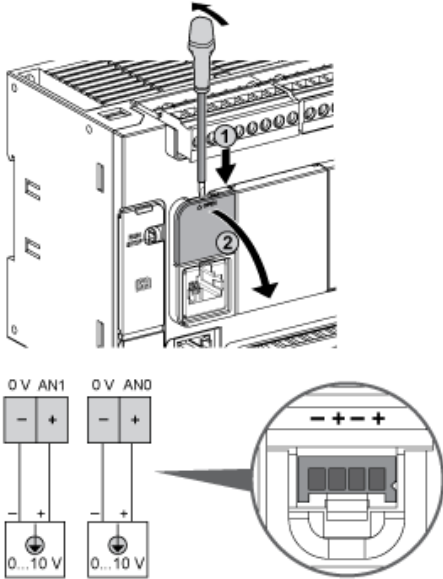

The (-) poles are connected internally.

| Pin | Wire Color |
|-----|------------|
| 0 V | Black      |
| AN1 | Red        |
| 0 V | Black      |
| AN0 | Red        |

Ethernet Connection

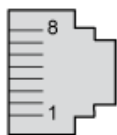

| Pin N° | Signal |
|--------|--------|
| 1      | TD+    |
| 2      | TD-    |
| 3      | RD+    |
| 4      | -      |
| 5      | -      |
| 6      | RD-    |
| 7      | -      |
| 8      | -      |

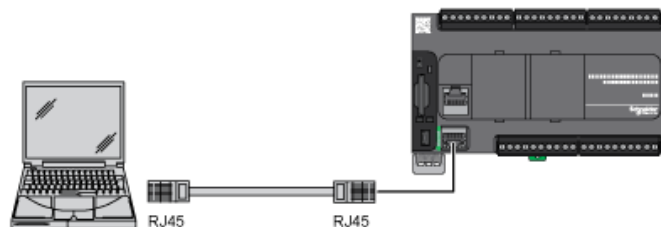

USB Mini-B Connection

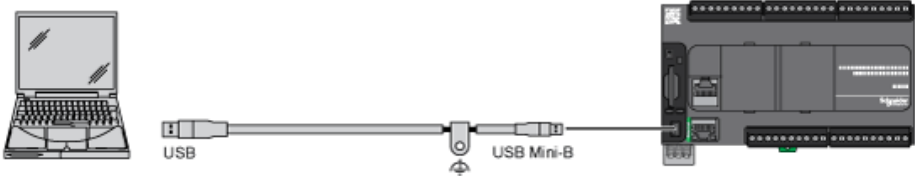

SL1 Connection

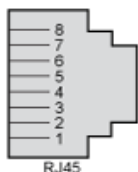

SL1

| N ° | RS 232 | RS 485  |
|-----|--------|---------|
| 1   | RxD    | N.C.    |
| 2   | TxD    | N.C.    |
| 3   | RTS    | N.C.    |
| 4   | N.C.   | D1 (A+) |
| 5   | N.C.   | D0 (B-) |
| 6   | CTS    | N.C.    |
| 7   | N.C.   | 5 Vdc   |
| 8   | Common | Common  |

N.C.: not connected

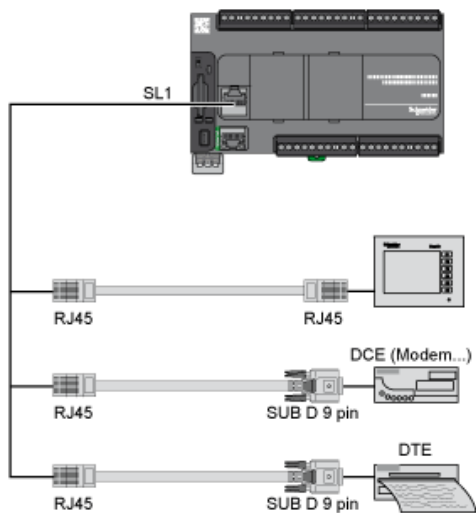

Derating Curves

Embedded Digital Inputs (No Cartridge)

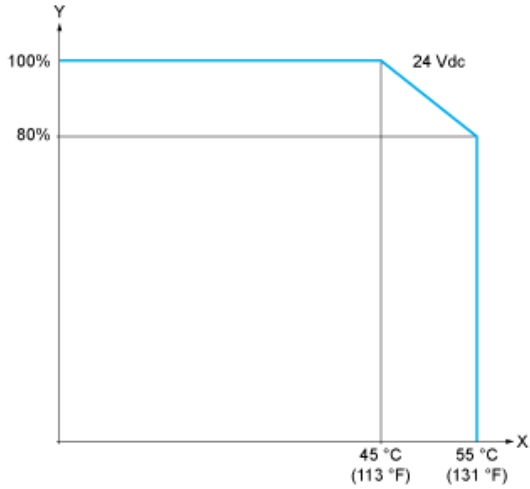

X : Ambient temperature  
Y : Input simultaneous ON ratio

Embedded Digital Inputs (with Cartridge)

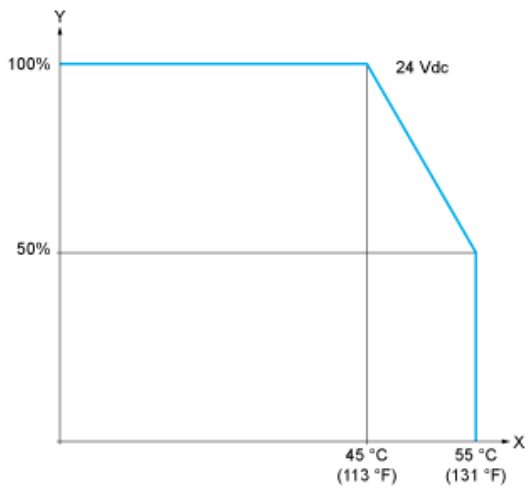

X : Ambient temperature  
Y : Input simultaneous ON ratio



Derating Curves

Embedded Digital Outputs (No Cartridge)

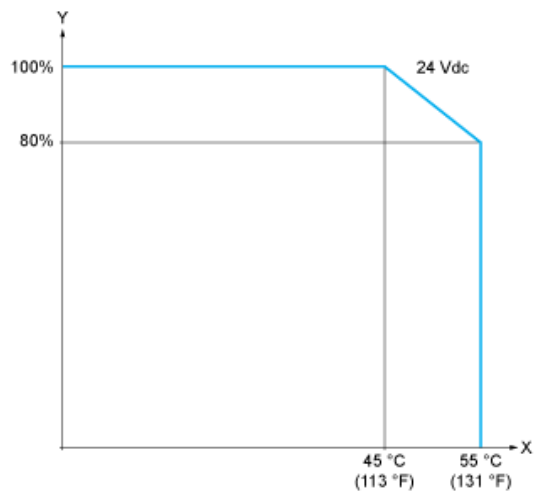

X : Ambient temperature  
Y : Output simultaneous ON ratio

Embedded Digital Outputs (with Cartridge)

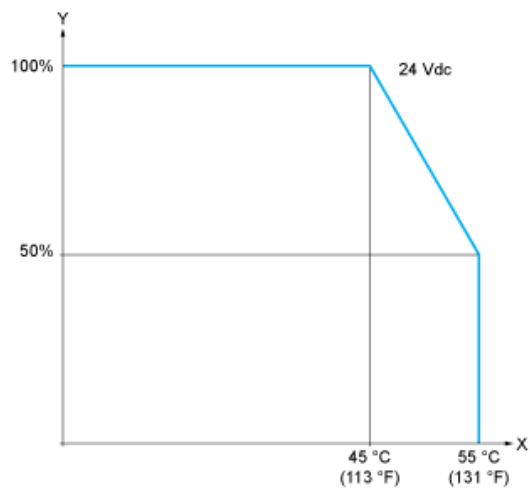

X : Ambient temperature  
Y : Output simultaneous ON ratio